

# Gtech

**Cordless Lawn Mower**

Model number: **CLM2.0**

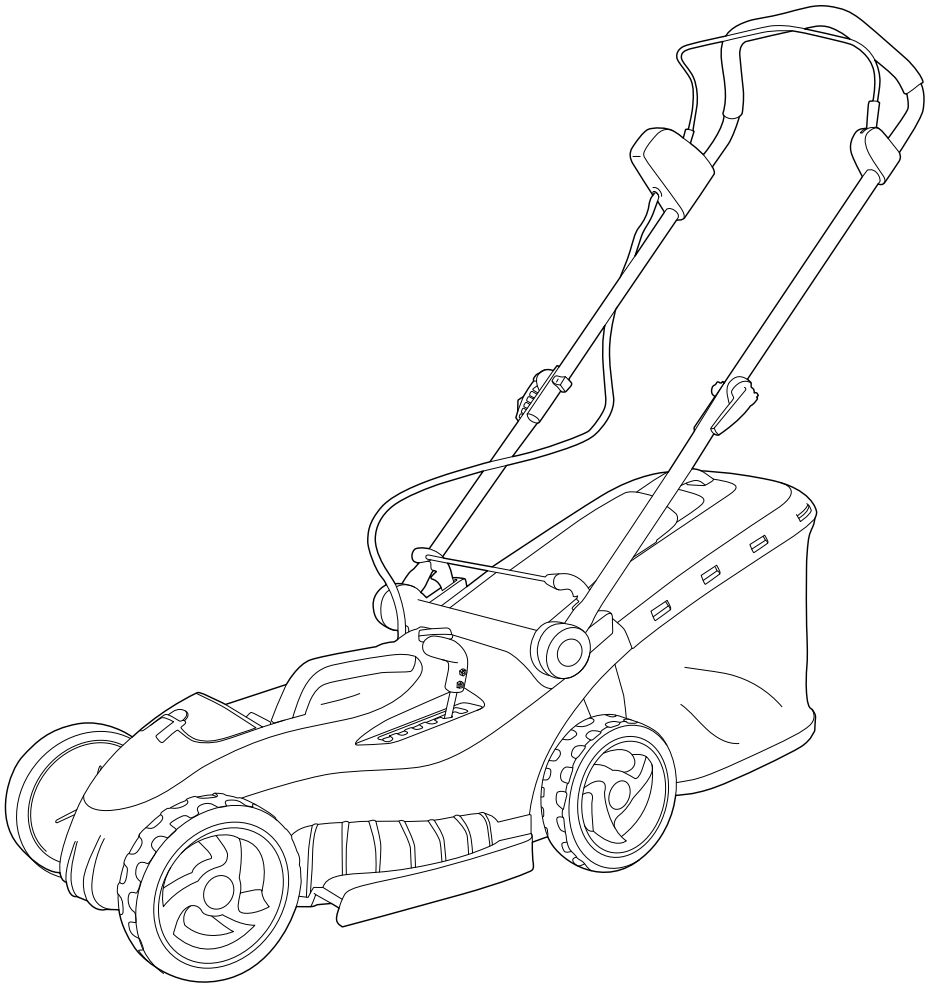

**OPERATING MANUAL**

Original Instructions

# IMPORTANT SAFEGUARDS:



**IMPORTANT: READ ALL INSTRUCTIONS BEFORE USE.  
RETAIN INSTRUCTIONS FOR FUTURE REFERENCE.**



Do not use in rain or leave outdoors whilst raining.



**WARNING:** Basic safety precautions should always be observed when using an electrical appliance to reduce the risk of fire, electrical shock or serious injury.

## Personal Safety:

- Only use the mower on grass and lawns, as described in this manual.
- Keep out of reach of children and animals at all times.
- Only use in daylight or good artificial light.
- Do not use while there are other people, especially children, nearby.
- Stay alert, watch what you are doing and use common sense when operating the mower.
- Do not use the mower while you are tired or under the influence of drugs, alcohol or medication. This may result in serious personal injury.
- Always be aware of your surroundings and stay alert for possible hazards.
- Use protective personal equipment such as safety glasses, non-skid safety shoes, sturdy gloves to reduce the risk of personal injury.
- Do not operate when barefoot or wearing open toed shoes.
- Dress appropriately. Do not wear loose clothing or jewellery and keep hair, clothing and gloves away from moving parts.
- Mow across slopes, not up and down, taking care when changing direction.
- Always be sure of your footing on slopes or in slippery conditions.
- Do not use on excessively steep slopes.
- Take particular care when reversing with the mower or pulling it towards you.
- Never touch the rotating blade.
- Do not stand in front of the protective flap when opened.
- Do not open the protective flap while the motor is running.
- Never operate the mower over gravel, as this risks flicking stones.
- Check the area where the mower is to be used and remove any objects that could jam or be thrown by the mower, such as stones and sticks.
- Avoid operating the mower on wet grass.
- Check the grass box regularly for any wear and deformation.
- Do not use the mower without the grass box or other protective guards in place.
- Never operate the mower with damaged guards or without the guards in place.
- Visually check the cutting tools and their fasteners for any damage before each use.
- To prevent imbalance, any damaged or worn-out parts should be replaced.
- When operating the mower ensure that both hands are correctly positioned on the handle.
- Only start the mower when your feet are a safe distance from the cutting blade.
- Do not tilt the mower when starting the motor.

- Do not operate the mower if it is incomplete or has unauthorised modifications.
- Keep all body parts, especially hands and feet, away from the blade at all times.
- Warning, the blade will continue to move after the motor is switched off.
- Ensure that the blade has fully stopped and safety key has been removed before:
  - leaving the mower
  - clearing a blockage
  - adjusting the cutting height
  - emptying the grass box
  - lifting or carrying the mower
  - tilting the mower to move
  - checking or cleaning the mower
  - carrying out any maintenance
- If the mower vibrates intensively, stop the motor fully and identify the cause.
- The operator is responsible for accidents or hazards occurring to other people at their property.
- This appliance is not intended for use by persons (including children) with reduced physical, sensory or mental capabilities or lack of experience or knowledge.
- Never modify the mower in any way.

### **Electrical safety:**

- Do not operate the mower in explosive atmospheres, such as in the presence of flammable liquids, gases or dust. Mowers create sparks, which may ignite the dust and fumes.
- Do not use the mower when a thunderstorm is approaching.
- Avoid body contact with earthed or grounded surfaces, such as pipes. There is an increased risk of electric shock if your body is earthed or grounded.
- Do not expose the mower to rain or wet conditions.

- Do not handle the charger or the mower with wet hands.
- Before charging check the power supply and charger cables for signs of damage or ageing.
- Do not expose the mower to temperatures exceeding 80°C, or leave the mower in direct sunlight or in the hot boot of a car for prolonged periods.

### **Battery safety:**

- Do not attempt to use the charger with any other product or to charge this product with any other charger.
- Do not use the charger in moist or wet conditions or outdoors.
- Disconnect the cable connectors by pulling the plug only, never the charger.
- Do not use a damaged charger.
- Never cover the ventilation slots.
- Never open the charger. In case of defect, contact Gtech.
- This product contains Li-Ion batteries. Do not incinerate batteries or expose to high temperatures, as they may explode.
- Do not charge the battery when the surrounding air temperature or the battery pack is below 0°C or above 40°C.
- After heavy use or in high temperatures the battery may become warm. Allow the product to cool for 30 minutes before charging.
- Use only with the battery pack supplied.
- Leaks from battery cells can occur under extreme conditions. If the liquid gets on your skin wash immediately with soap and water. If the liquid gets into your eyes, flush them immediately with cold water for a minimum of 10 minutes and seek urgent medical attention.
- Protect the battery against excessive temperatures and fire.

- Do not store the battery outside for prolonged periods of time over the winter months.
- Do not dispose of the battery pack into household waste, fire or water. The battery pack should be collected, recycled or disposed of in an environmentally friendly manner. Discharge your battery pack by operating your Cordless Lawn Mower. Remove the battery pack from the housing and cover the battery pack connections with heavy duty ventilation tape to prevent a short circuit and energy discharge. Do not attempt to open or remove any of the components.
- Remove the battery and charger from the mains when fully charged.
- Unplug the charger from the mains and battery when fully charged.













### **Service:**

- Do not use the mower if the switch does not turn on or off. Any power tool that cannot be controlled by the switch is dangerous and must be removed or replaced.
- Before any servicing and cleaning take out the safety key and remove the battery.
- Check all visible fixing screws and nuts, especially on the cutter bar, to ensure they are tightened properly.
- Do not keep the mower in a damp room.
- Before using the the mower and after any impact, check for signs of wear and damage and repair or replace as necessary.
- Use only genuine replacement parts. This will ensure that the safety of the the mower is maintained.
- Do not attempt to repair any damaged parts on the mower unless you are qualified to do so.
- Please contact Gtech on 01905 345891 if you have any queries about your product.

### **Intended Use:**

- This product is intended for DOMESTIC USE ONLY.

# Warning Label Descriptions

|   |   |  |  |
|---|---|--|--|
|  | Warning/ Caution.   |   | Remove safety key before servicing and cleaning.   |
|  | Beware of severing toes or hands. Do not put hands or feet near a rotating blade. |   | Dangerous voltage.   |
|  | Read the instruction manual.  |   | Keep bystanders at a safe distance (at least 5m).  |
|  | Caution: Wait until blades stop rotating when switched off.                       |   | Always keep the lawnmower on the ground when mowing. Tilting or lifting the lawnmower may cause stones to be thrown out. |
|  | Do not mow in the rain or leave the lawnmower outdoors while raining.             |   | Do not dispose of Li-Ion battery with general household waste.   |
|  | Grass bin empty.  |   | Grass bin full.  |
|   |   |  | Guaranteed Sound Power Level   |

- Please read this manual carefully. Familiarise yourself thoroughly with the controls and proper use of this machine. You should know how the machine works and how to immediately switch it off.
- Never let children use this mower. Never let adults work with this mower if not properly trained.
- Do not let any persons, especially small children, or pets near you while mowing.
- Take care not to slip or fall while mowing.

# Thank you for choosing a Gtech Cordless Lawn Mower.

"I started Gtech to create sensible, easy to use products, which do a great job. Your opinion is important to us and we will use your feedback to improve our products and services and let other people know what it's like to be part of the Gtech family."

Nick Grey – Inventor, Owner of Gtech

Please take the time to write a review of the Gtech Cordless Lawn Mower by visiting [www.gtech.co.uk/product-reviews](http://www.gtech.co.uk/product-reviews) or if you didn't purchase directly from Gtech please leave a review with the retailer.

Make a note of your product serial number code for future reference. You can find this in the grass box flap.

\_\_\_\_-\_\_\_\_-\_\_\_\_~  
\_\_\_\_-\_\_\_\_-\_\_\_\_~  
\_\_\_\_-\_\_\_\_-\_\_\_\_~  
\_\_\_\_-\_\_\_\_-\_\_\_\_~

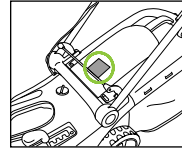

## What's in the box

- 1 Chassis
- 2 Grass box
- 3 Charger
- 4 Battery
- 5 Locking handle x2
- 6 Threaded insert x2
- 7 Upper handle
- 8 Bolt x2
- 9 Securing washer x2

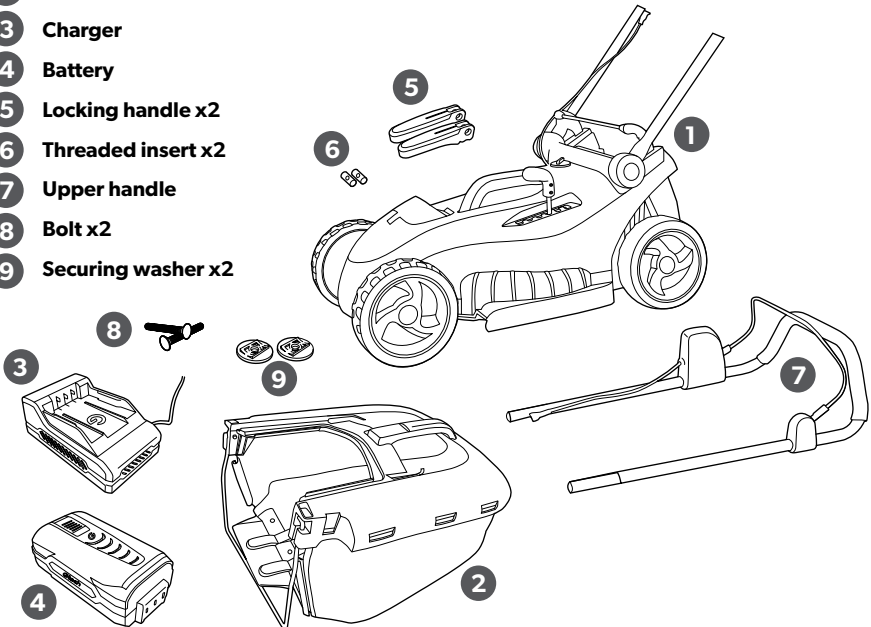

## Handle set-up

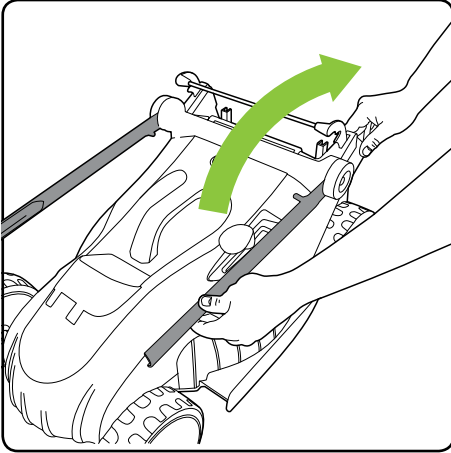

Pull the Lawn Mower lower handles back individually.

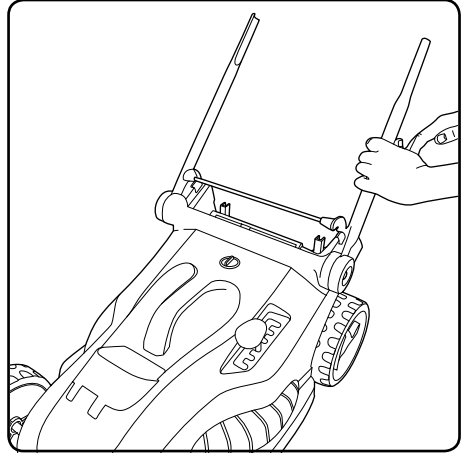

Once in position, they will click and lock into place.

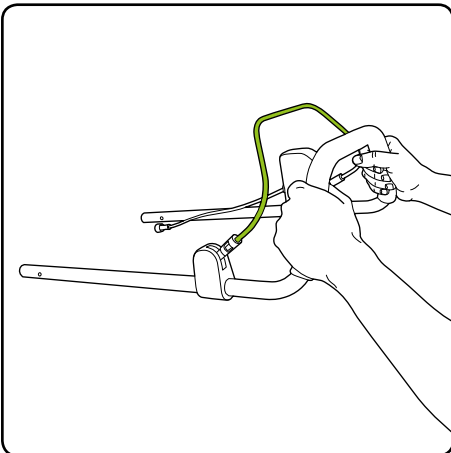

Take the upper handle of the mower, ensuring the green start activation handle is positioned at the top with the arms facing away from you.

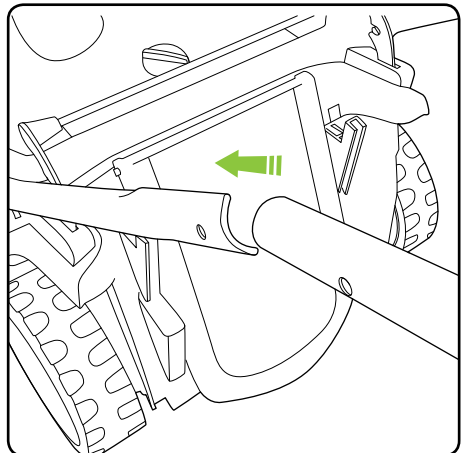

Align the upper handles inside the lower handles.

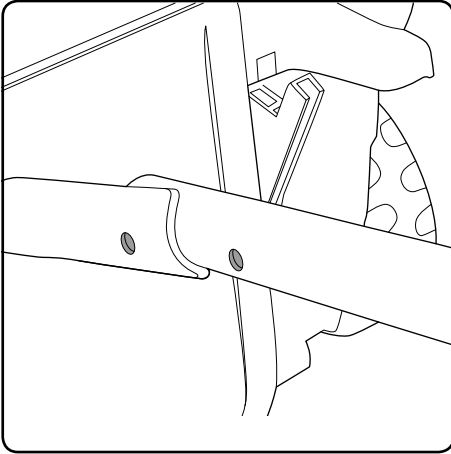

Line up the holes on the upper and lower handles.

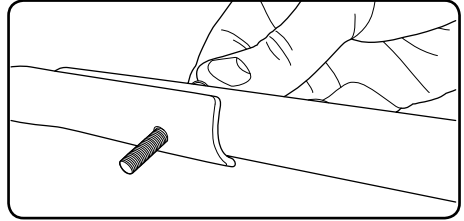
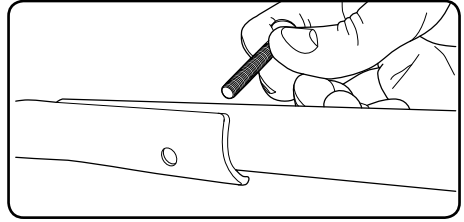

Thread the supplied bolt through the holes in the upper and lower handles. Do this on both sides of the mower.

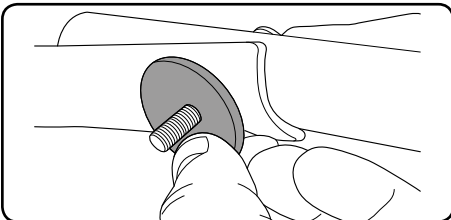
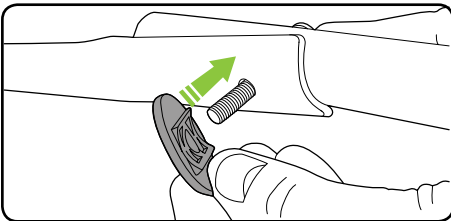

Thread the securing washer over the supplied bolt, ensuring the flat side is on the outside. The plastic moulding on the inside of the securing washer will sit flush with the pole when in place. Do the same on the other side.

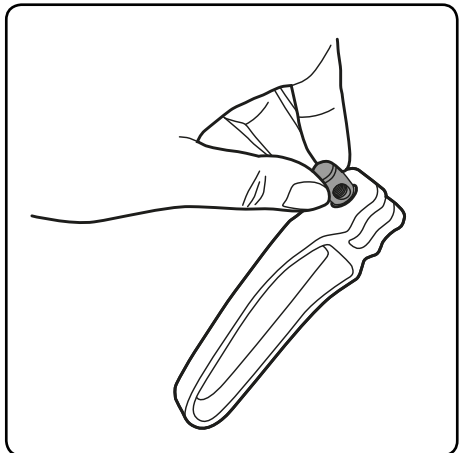

Place the threaded inserts into the holes at the end of the locking handle.



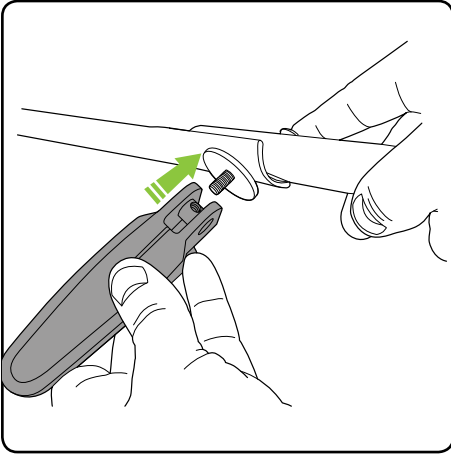

Line up the bolt with the insert of the locking handle, ensuring the handle is straight.

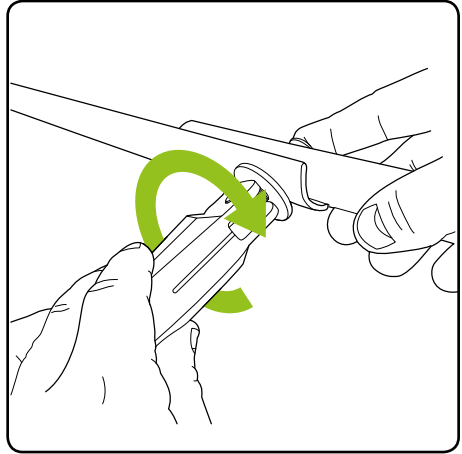

Twist the locking handle to tighten.

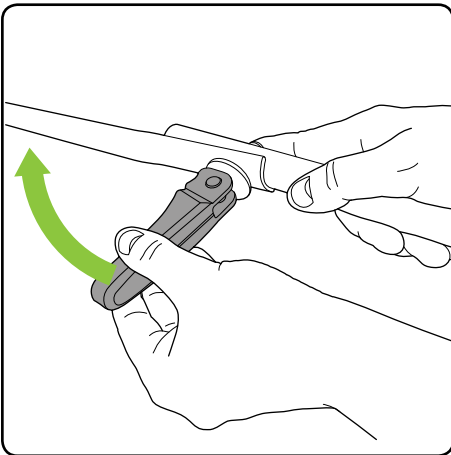

Push the locking handle down towards the mower to lock the handle in place.

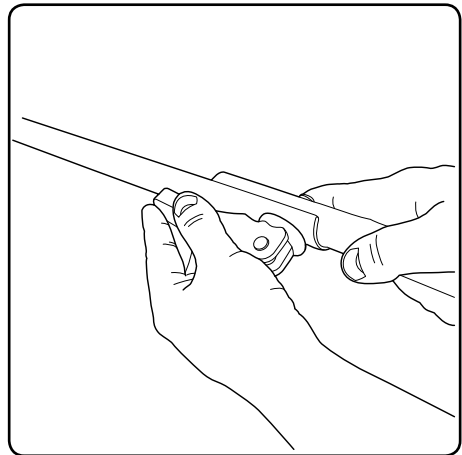

Ensure the handle is tight, not loose.  
Do the same with the locking handle on the other side.

## Connecting the power cables

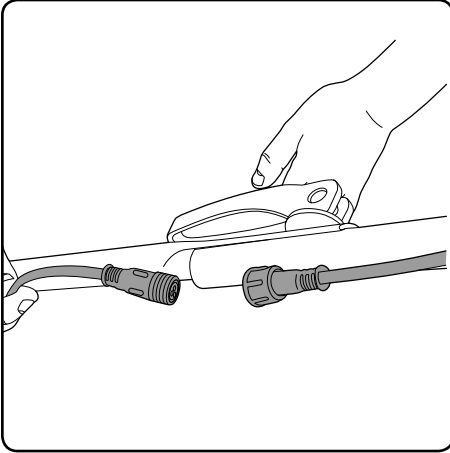

The power cables are located below the locking handle on the left side of the mower's handle.

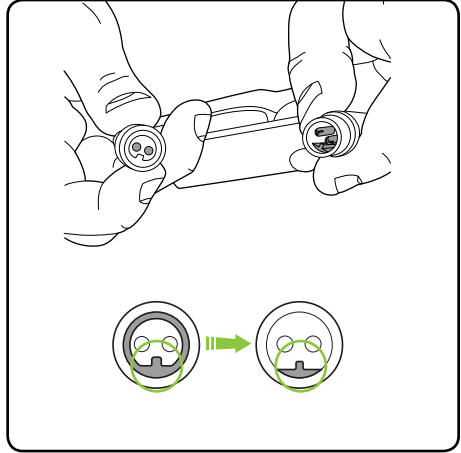

Line up the keyway on the end of the upper cable with the two holes in the lower power cable.

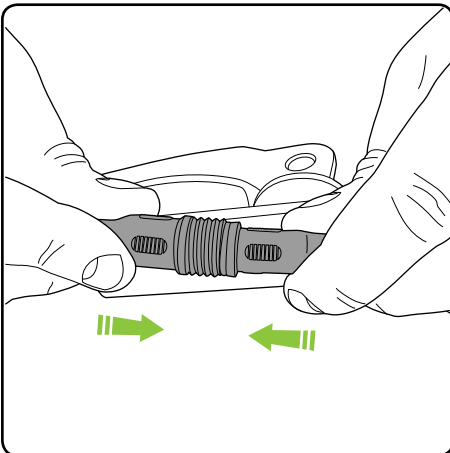

Push the power cables together until they lock in place.

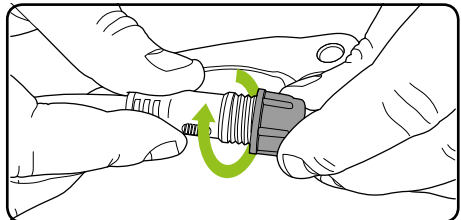
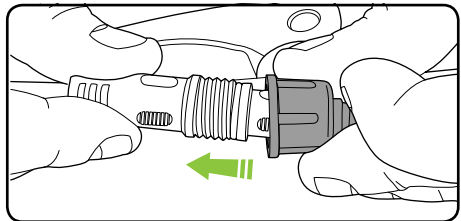

Slide the collar over the power cables. Screw the collar in a clockwise direction to tighten. Thread until tight.

## Grass box assembly

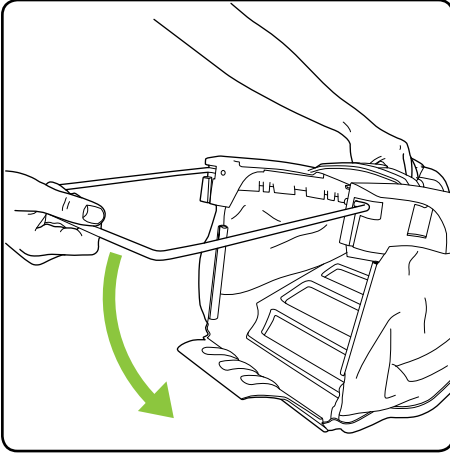

Lower the frame down towards the base.

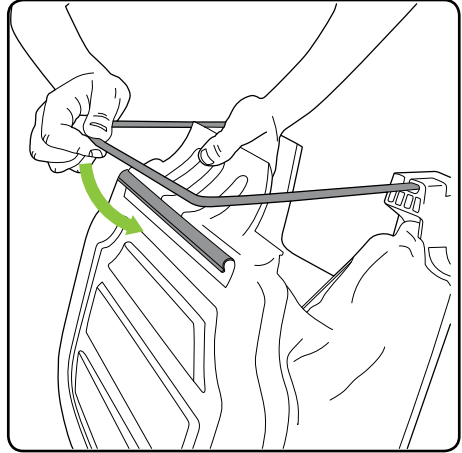

Hook the base of the box over the metal frame.

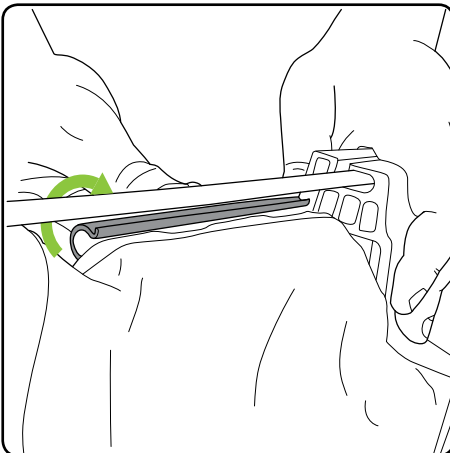

Repeat these steps for the locking parts on each edge of the bin.

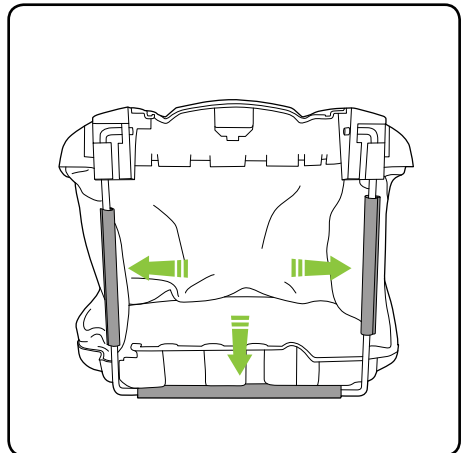

Each edge of the metal frame should now be locked into place.

## Fitting the grass box

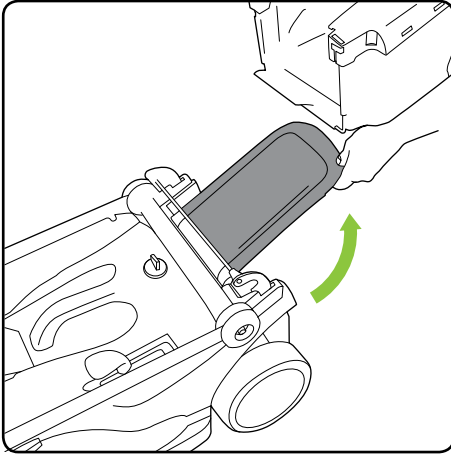

To fit the grass box onto the mower, lift up the protective flap.

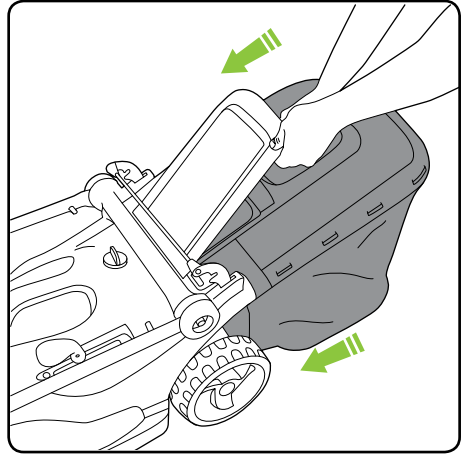

Insert the grass box into the back of the mower.

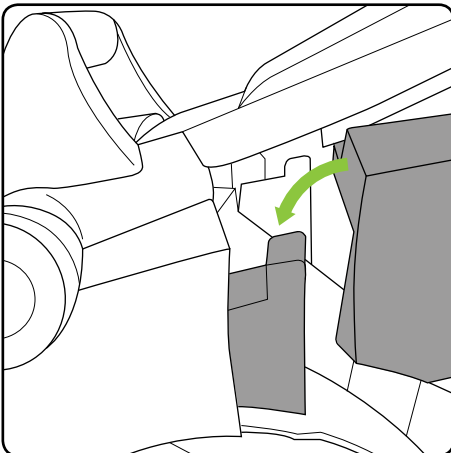

Ensure the hooks lock into place.

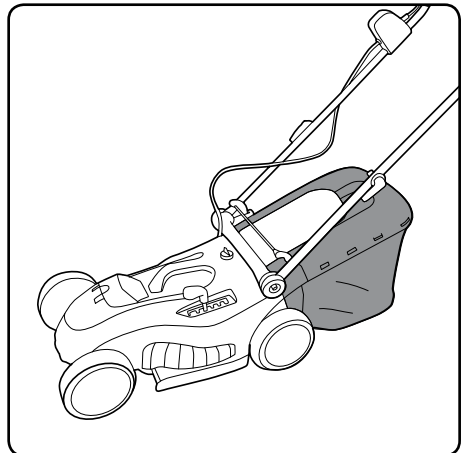

The grass box is now fully assembled.

## Inserting the battery

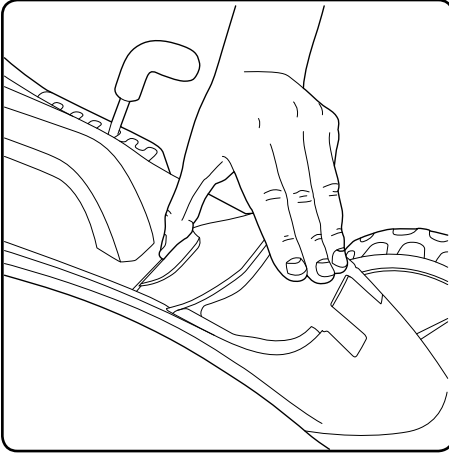

Lift up the clear visor to reveal the battery housing.

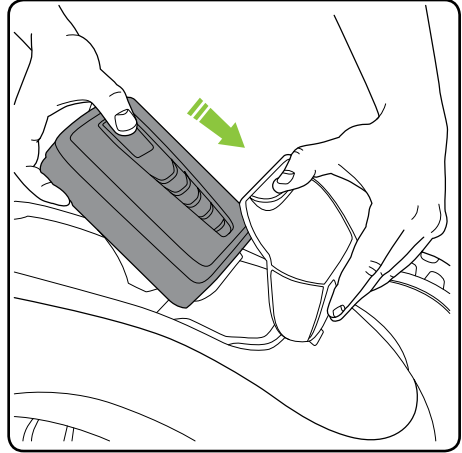

Ensure the 'G' logo is facing upwards when you slide the battery into the battery housing. It will click into place once fitted correctly.

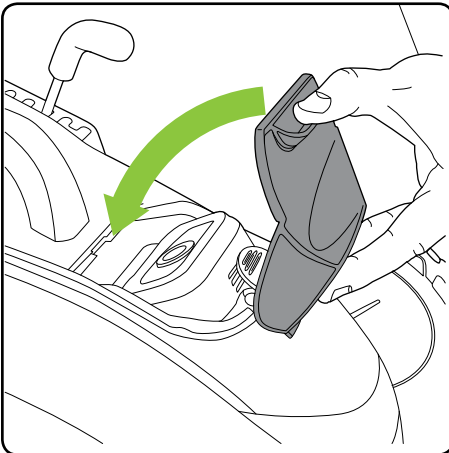

The visor will return to its original position.

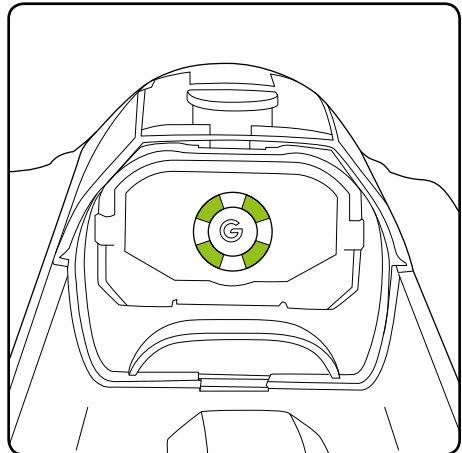

The state of charge indicator on the battery will be visible through the visor.

## The safety key

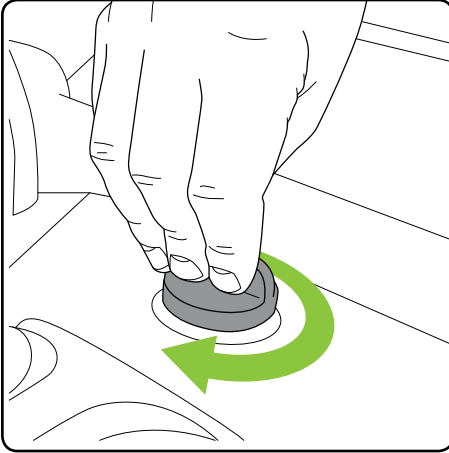

The mower will not work without the safety key. Rotate it 90° clockwise to operate.

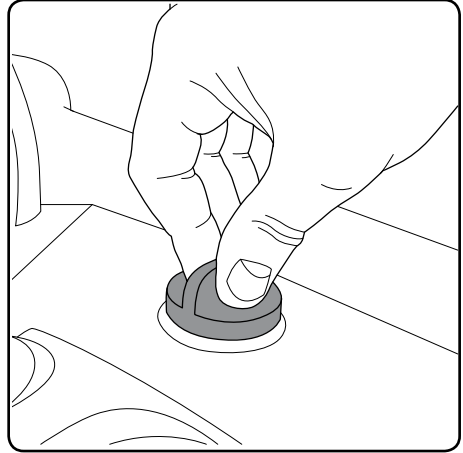

Once correctly in place, the mower will be ready to use.

Remove the key before you carry out any maintenance, clear any grass, carry the mower or put your hands near the blade.

## Operating the Cordless Lawn Mower

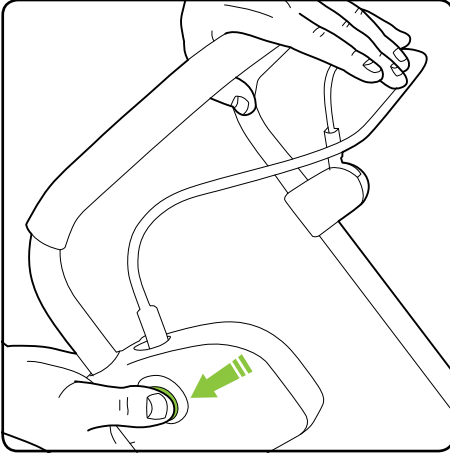

To operate the mower, press and hold the green safety button and then pull the lever under the handle.

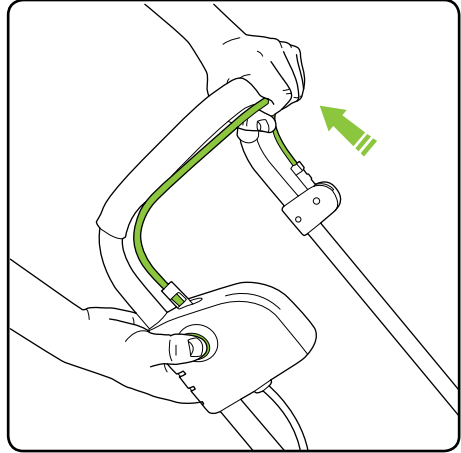

Pull the lever to the handle to start the mower. Releasing the lever will stop the mower.

Ensure the safety key has been activated before use.

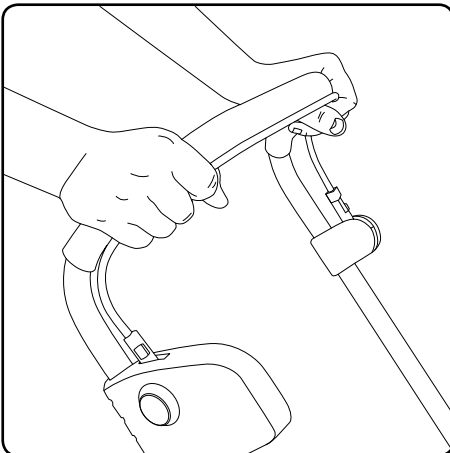

Once the mower is activated, you can release the safety button.

## Adjusting the cutting height

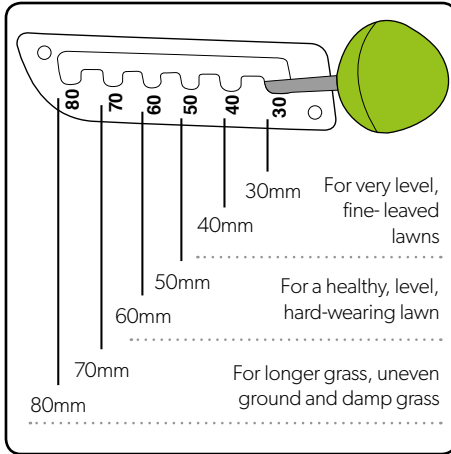

The mower has 6 cutting height settings between 30mm and 80mm.

Note that the 30mm and 40mm settings will scalp uneven lawns and reduce your lawn's resistance to wear and drought.

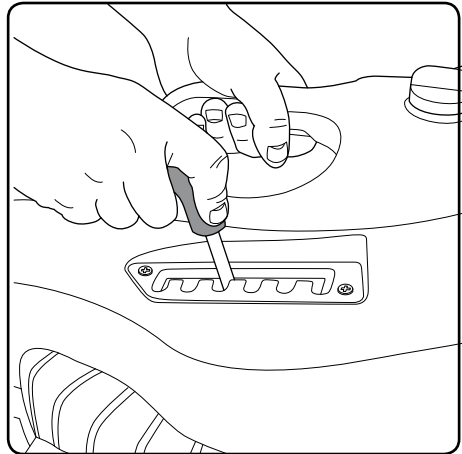

To adjust the height, hold the lever firmly and move it into the notch required.

**When mowing on uneven ground, it is suggested you test the cutting height on a small patch of grass, to avoid cutting too deep and creating bald patches.**

## Using the Cordless Lawn Mower

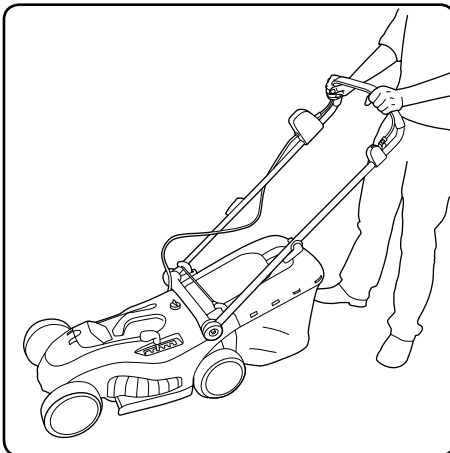

Push the mower along at a walking pace when mowing.

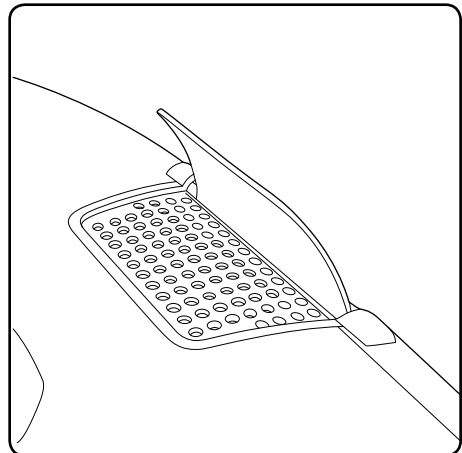

When the filling indicator flap closes, it is time to empty the bin. Note: if the bin over-fills, the grass chute will clog and the flap will close again.



**WARNING:** to reduce risk of personal injury, wait for the blade to stop rotating and remove the safety key before adjusting the cutting height.



## Removing and emptying the grass box

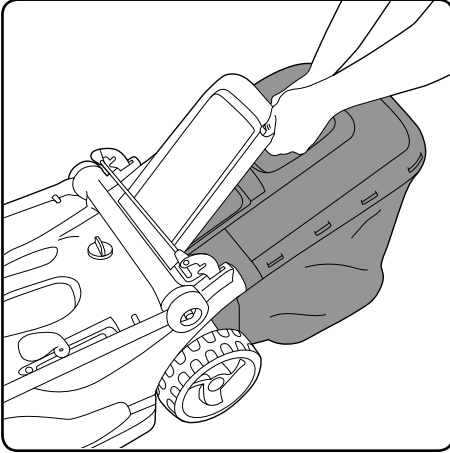

Lift the protective flap at the rear of the mower and grasp the green handle attached to the grass box.

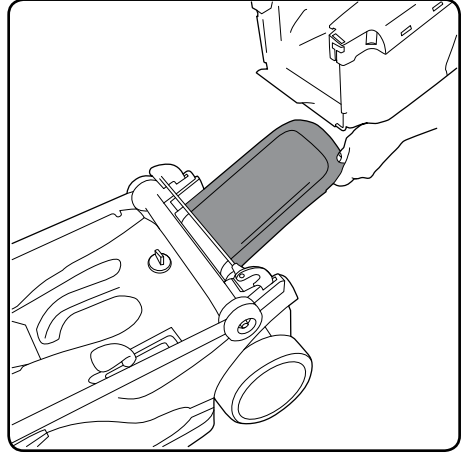

Whilst still lifting the protective flap, lift and pull the grass box towards you to remove from the mower.

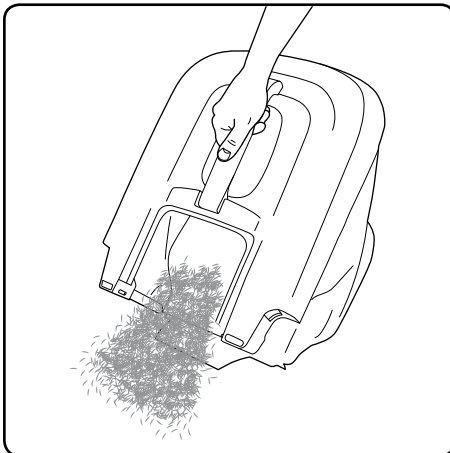

Empty your grass clippings in an appropriate location.

## Charging the battery

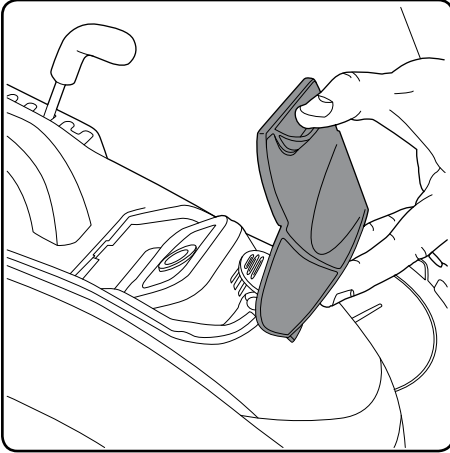

Reveal the battery by lifting the cover visor.

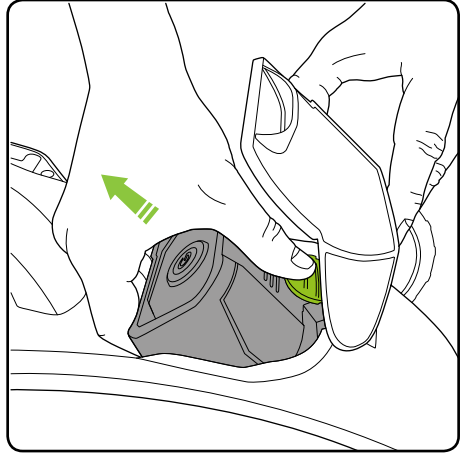

To unlock the battery, push the release latch located under the visor, then pull out the battery.

## State of charge indicator

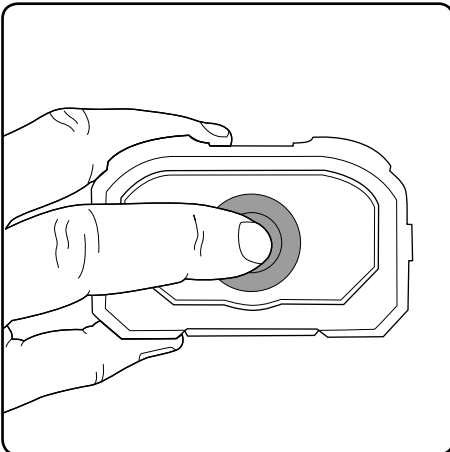

Press the button on the back of the battery to check how much charge there is.



Figures are approximate.

The number of LEDs that are lit up show the state of charge.

## Charging the battery

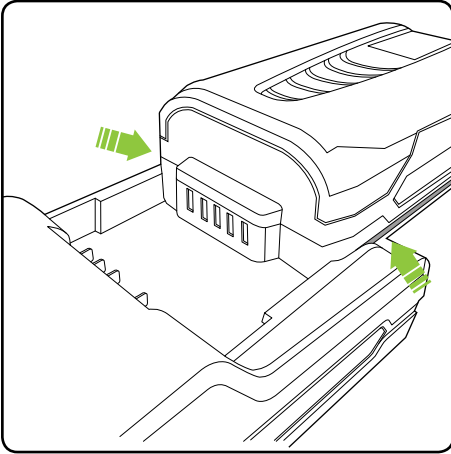

With the 'G' logo facing upwards on the battery, line up the runners on the sides of the battery with the runners on the battery charge stand and slide onto charger.

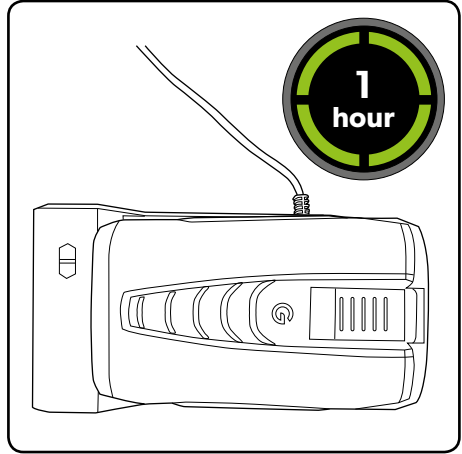

The charger will display a solid red light to indicate it is plugged in. Once the charging process has started, a green light will flash.

Charge time is approximately 1 hour. A solid green light will be displayed to indicate that the battery is fully charged.

## Carrying the Cordless Lawn Mower

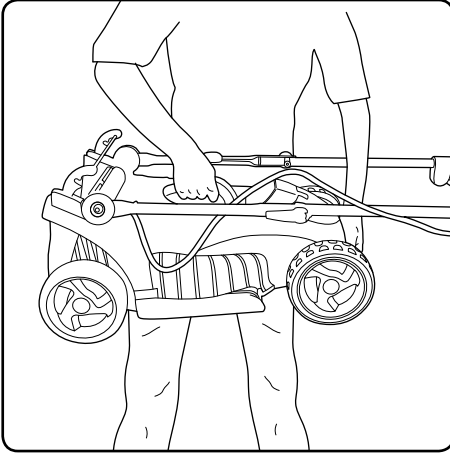

Before carrying the mower, make sure the safety key is removed to avoid starting it accidentally. The easiest way to carry the mower is by holding the middle carry-handle and the front of the mower.

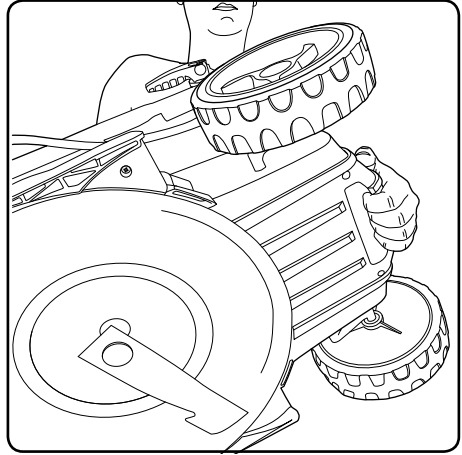

There is a hand-hold under the front of the mower.

## Product Care

---



Wear protective gloves when handling, cleaning or replacing the blade.



To reduce the risk of injury ensure that safety key is removed when the mower is not in use, being transported, handled or stored.

To ensure that your Cordless Lawn Mower gives you long and reliable service, carry out the following maintenance regularly:

- Check for obvious defects such as a loose, dislodged, worn or damaged blade, loose fixings and worn, damaged, or loose parts.
- Check that any covers and guards are correctly fitted and undamaged.
- Always clean the cutting blade after use and apply a lubricating oil or spray before storage.
- Before use, check the condition of the cutting edges of the blade and ensure the blade fixings are secure.
- Do not use water, solvents or polishes to clean the mower. Wipe clean with a dry cloth.
- Do not use abrasive materials to clean the product, and do not immerse it in water.
- Store it in a secure, dry place, out of reach of children. Do not expose to moisture.

**PLEASE NOTE:** if the product needs to be repaired or replaced, only use replacement parts supplied by the manufacturer.

Spare parts can be purchased from Grey Technology Ltd.

Tel: **01905 345 891**

Web: **[www.gtech.co.uk/support](http://www.gtech.co.uk/support)**

## Troubleshooting

|  |   |
|--|---|
| Motor not running                            | <ol style="list-style-type: none"><li>1. Charge battery</li><li>2. Check safety key is inserted</li><li>3. Check switch operation</li></ol>   |
| Irregular running/machine vibrating strongly | <ol style="list-style-type: none"><li>1. Blade may be defective</li><li>2. Blade may be loose</li></ol>   |
| Poor cutting/collection performance          | <ol style="list-style-type: none"><li>1. Empty/ unblock grass box</li><li>2. Charge/ check battery</li><li>3. Cutting height may need adjusting</li><li>4. Blade may be blunt</li></ol> |
| Mower leaves cut grass on lawn               | <ol style="list-style-type: none"><li>1. Check and clear the grass chute</li><li>2. Clean the bin fabric</li></ol>  |
| Struggling to cut/jamming                    | <ol style="list-style-type: none"><li>1. Push the mower more slowly</li><li>2. Increase cutting height</li><li>3. Check for a build-up of grass</li></ol>                               |
| Charger flashing red (slow)                  | Battery too hot - allow to cool   |
| Charger flashing red (rapid)                 | Battery fault - call Gtech  |

## Product Support

If these initial tips don't solve your problem, we have various other ways to help.

**Visit: [www.gtech.co.uk/support](http://www.gtech.co.uk/support)**



Online



Live chat support



[support@gtech.co.uk](mailto:support@gtech.co.uk)



How to Videos

## GTECH CORDLESS LAWN MOWER TECHNICAL SPECIFICATION

|                              |  |
|------------------------------|--|
| Voltage                      | 48V  |
| Battery capacity             | 2.0 Ah Li-Ion  |
| Blade speed                  | 2800 rpm   |
| Grass box capacity           | 50L  |
| Charge time                  | 1 hour   |
| Cutting Width                | 420mm  |
| Cutting height adjustment    | 30mm – 80mm  |
| Protection type              | IPX 4  |
| Measured sound power level   | 88.83 dB (A); K= 2.29 dB (A)   |
| Guaranteed sound power level | 96 db(A)   |
| Sound pressure level         | 77.9 dB (A); K= 3 dB (A)   |
| Vibration                    | Left handle: 0.581 m/s <sup>2</sup><br>Right handle: 1.274 m/s <sup>2</sup><br>K= 1.5 m/s <sup>2</sup> |
| Weight                       | 13.5kg   |
| Charger INPUT                | 200V-240V~50/60 HZ   |
| Charger output voltage       | 54.6V DC ---- 2A   |

## Environmental and Product Recycling

The  symbol indicates that this product is covered by legislation for waste electrical and electronic products (EN2002/96/EC)

When the product has reached the end of its life please do not dispose of it with general household waste. Consider the environment and take it to a recognised recycling facility.

The product contains a Li-Ion battery which should not be disposed of with general household waste. The battery should be disposed of properly with the product at a recycling facility.

Call your local council, civic amenity site, or recycling centre for information on the disposal and recycling of electrical products.

Alternatively visit [www.recycle-more.co.uk](http://www.recycle-more.co.uk) for advice on recycling and to find your nearest recycling facilities.

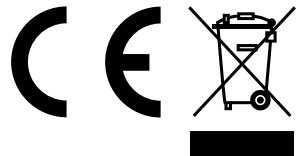

## WARRANTY – REGISTRATION

---

Visit [www.gtech.co.uk/warrantyregistration](http://www.gtech.co.uk/warrantyregistration) to register your product to ensure that we have all the information required to provide you with quick and efficient support.

**You will need your product's serial code.**

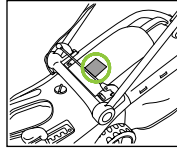

If you purchased directly from Gtech your details are already registered and your 2 year warranty will start automatically.

If you purchased from an authorised Gtech retailer, please register your warranty within 3 months and you will need to provide proof of purchase to support any claim against your warranty.

## WARRANTY – TERMS AND CONDITIONS

---

Your Gtech Cordless Lawnmower is guaranteed against material or manufacturing faults for 2 years from the date of purchase, subject to the following terms and conditions:

### WHAT ISN'T COVERED

**Gtech does not guarantee the repair or replacement of a product as a result of:**

- Normal wear and tear.
- Accidental damage, faults caused by negligent use or care, misuse, neglect, careless operation or handling of the mower which is not in accordance with the mower operating manual.
- Use of the mower for anything other than normal domestic garden purpose.
- Use of parts and accessories which are not Gtech genuine components.
- Faulty installation (except where installed by Gtech).
- If it is modified in any way.
- Repairs or alterations carried out by parties other than Gtech or its authorised agents.
- If you are in doubt as to what is covered by your warranty, please call the Gtech Customer Care Helpline on 01905 345 891.

### SUMMARY

- The guarantee becomes effective at the date of purchase (or the date of delivery if this is later).
- You must provide proof of delivery/purchase before any work can be carried out on the vacuum cleaner. Without this proof, any work carried out will be chargeable. Please keep your receipt or delivery note.
- All work will be carried out by Gtech or its authorised agents.
- Any parts which are replaced will become the property of Gtech.
- The repair or replacement of your vacuum cleaner is under guarantee and will not extend the warranty period
- The guarantee provides benefits which are additional to, and do not affect, your statutory rights as a consumer.



# EC Declaration of Conformity

We herewith declare,

Grey Technology Ltd  
Brindley Road  
Warndon  
Worcester  
WR4 9FB

That the following machine complies with the appropriate basic safety and health requirements of the EC Directive based on its design and type, as brought into circulation by us.

In case of alteration of the machine, not agreed upon by us, this declaration will lose its validity

Product's name / function: Lawn mower / for cutting grass.  
Machine Type: A022009 Or CLM2.0  
Rated voltage: 48VDC  
Measured sound power level: 88,83 dB(A) K= 2.29 dB (A)  
Guaranted sound power level: 96dB(A)

Notified Body: Conformity assessment method to Directive 2000/14/EC and 2005/88/EC  
The EC type-examination certificate is issued by SGS  
Notified body of Noise directive:  
AV Technology  
Unit 2 Easter Court Europa Boulevard Warrington, Cheshire,  
WA5 7ZB, United Kingdom.  
Notified Body number:1067

Applicable EC Directives: EMC Directive 2014/30/EU  
Machinery Directive 2006/42/EC  
Noise Directive 2000/14/EC and 2005/88/EC  
RoHs Directive 2011/65/EU

Applicable Harmonized Standards: EN 60335-1  
EN 60335-2-77  
EN 55014-1  
EN 55014-2  
EN 62321

Authorized Signature/Date/ Place: 2017-11-15/JIAXING

Title of Signatory: Gtech (Grey Technology)

Name and address of the person authorised to compile the technical file, who must be established in the community:

Nick Grey  
Grey Technology Ltd  
Brindley Road  
Warndon  
Worcester  
WR4 9FB





# Gtech

## **Grey Technology Limited**

Brindley Road, Warndon, Worcester WR4 9FB

email: [support@gtech.co.uk](mailto:support@gtech.co.uk)

telephone: 01905 345891

[www.gtech.co.uk/support](http://www.gtech.co.uk/support)