

LawnMaster®

Instruction Manual

24V Lithium-Ion Cordless Hedge Trimmer CLHT2452

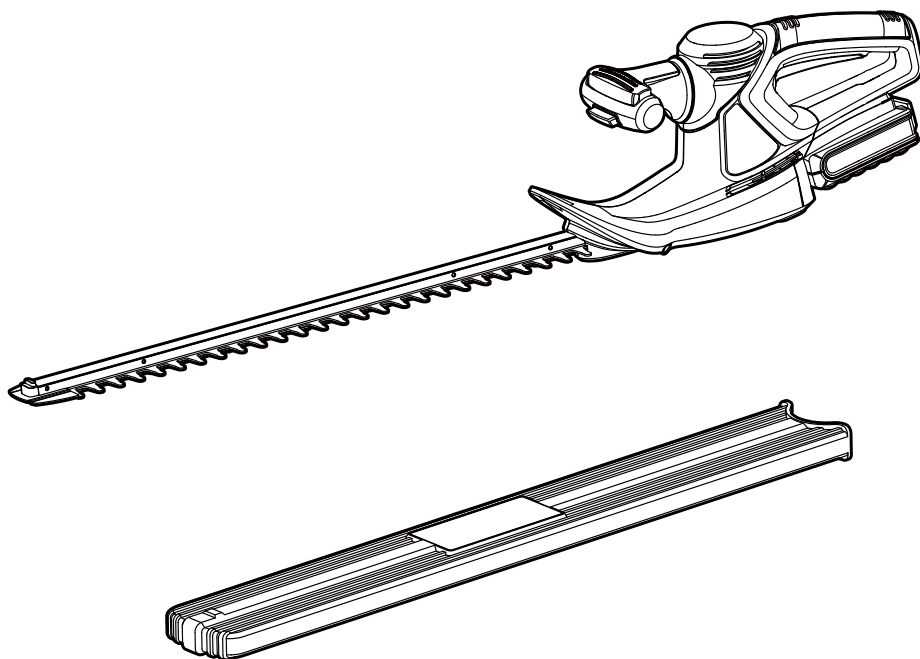

Original Instructions



WARNING: Read all safety instructions carefully before assembling and operating this machine. Ensure the machine has been assembled correctly and safely. Keep the instructions safe and pass them on to any subsequent user so that the information is always available.



UK
CA



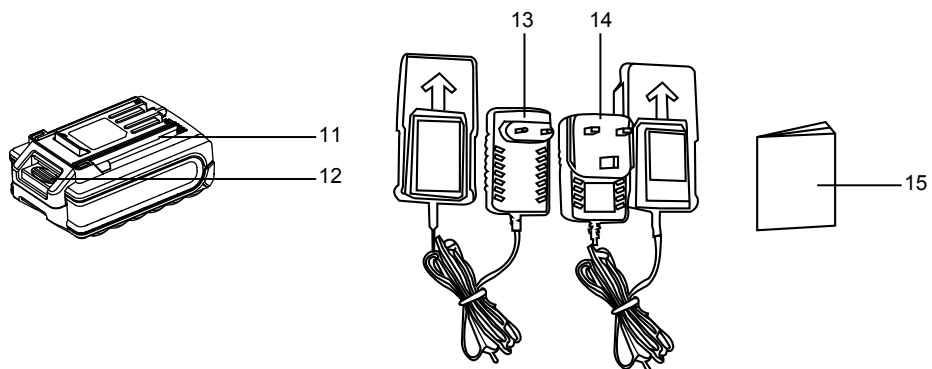
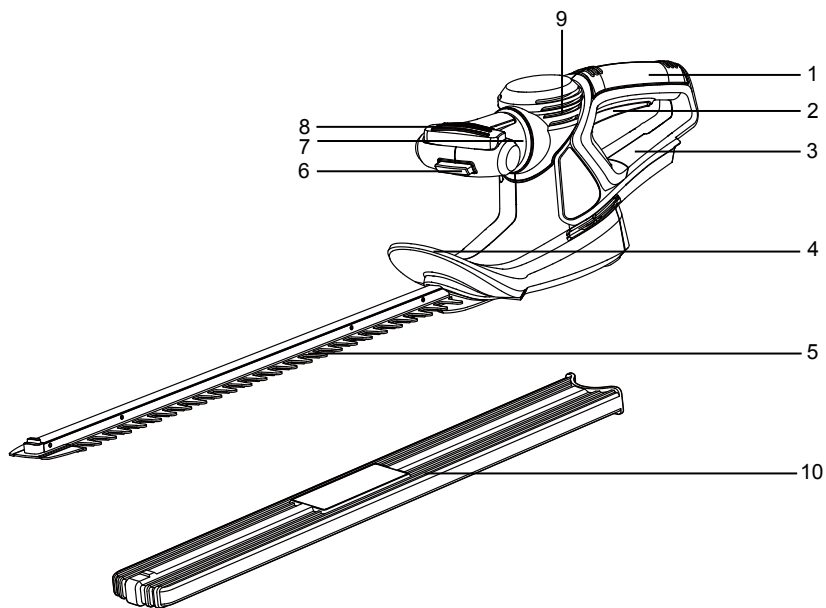















TABLE OF CONTENTS

Section	Page
Symbols	5-6
Safety Information	7-16
In the Box	16
Assembly	17
Operation	18-21
Maintenance	22-23
Troubleshooting	24
Technical Data	25
Recycling and Disposal	26

SYMBOLS

The following warning symbols appear throughout this manual and indicate the appropriate safety measures you should take when operating and maintaining the appliance.

SYMBOL	DESIGNATION/EXPLANATION
	Caution.
	Read instruction manual.
	Wear eye and ear protection.
	Do not use the hedge trimmer in the rain or on wet hedges.
	Noise level specification L_{WA} in dB(A).
	Cutting length.
	Protection Class II.
	Only recharge battery packs with the supplied charger indoors.
	Do not dispose of electrical equipment in domestic waste.
	Batteries contain Li-ion, waste batteries should be sorted for ecofriendly disposal. Do not dispose of waste batteries as unsorted municipal waste.
	Do not dispose of battery packs in rivers or immerse in water.
	Do not dispose of battery packs in fire.
	Do not subject the battery to direct sunlight over long periods and do not leave it on or near a heat source (max. 60°C).
	Recycle electrical waste products in an environmentally safe way where facilities exist.

SYMBOLS



WARNING

To avoid serious personal injury, do not attempt to use this product until you read thoroughly and understand completely the instruction manual.

If you do not understand the warnings and instructions in the instruction manual, do not use this product.

SAFETY INFORMATION



WARNING

READ CAREFULLY BEFORE USE. KEEP FOR FUTURE REFERENCE.

Work Area Safety

- Keep work area clean and well lit. Cluttered or dark areas invite accidents.
- Do not operate power tools in explosive atmospheres, such as in the presence of flammable liquids, gasses or dust. Power tools create sparks which may ignite the dust or fumes.
- Keep children and bystanders away while operating a power tool. Distractions can cause you to lose control.

Electrical Safety

- Avoid body contact with earthed or grounded surfaces, such as pipes, radiators, ranges and refrigerators. There is an increased risk of electric shock if your body is earthed or grounded.
- Do not expose power tools to rain or wet conditions. Water entering a power tool will increase the risk of electric shock.

Personal Safety

- Stay alert, watch what you are doing and use common sense when operating a power tool. Do not use a power tool while you are tired or under the influence of drugs, alcohol or medication. A moment of inattention while operating power tools may result in serious personal injury.
- Use personal protective equipment. Always wear eye

SAFETY INFORMATION

protection. Protective equipment such as dust mask, nonslip safety shoes, hard hat, or hearing protection used for appropriate conditions will reduce personal injuries.

- Prevent unintentional starting. Ensure the switch is in the off-position before connecting to power source and/or battery pack, picking up or carrying the tool. Carrying power tools with your finger on the switch or energising power tools that have the switch on invites accidents.
- Remove any adjusting key or wrench before turning the power tool on. A wrench or a key left attached to a rotating part of the power tool may result in personal injury.
- Do not overreach. Keep proper footing and balance at all times. This enables better control of the power tool in unexpected situations.
- Dress properly. Do not wear loose clothing or jewellery. Keep your hair, clothing and gloves away from moving parts. Loose clothes, jewellery or long hair can be caught in moving parts.
- If devices are provided for the connection of dust extraction and collection facilities, ensure these are connected and properly used. Use of dust collection can reduce dust-related hazards.

Power Tool Use and Care

- Recharge only with the charger specified by the manufacturer. A charger that is suitable for one type of battery pack may create a risk of fire when used with another battery pack.
- Use power tools only with specifically designed battery packs. Use of any other battery packs may create a risk of

SAFETY INFORMATION

injury and fire.

- When battery pack is not in use, keep it away from other metal objects, like paper clips, coins, keys, nails, screws or other small metal objects, that can make a connection from one terminal to another. Shorting the battery terminals together may cause burns or a fire.
- Under abusive conditions, liquid may be ejected from the battery; avoid contact. If contact accidentally occurs, flush with water. If liquid contacts eyes, additionally seek medical help. Liquid ejected from the battery may cause irritation or burns.
- Do not force the power tool. Use the correct power tool for your application. The correct power tool will do the job better and safer at the rate for which it was designed.
- Do not use the power tool if the switch does not turn it on and off. Any power tool that cannot be controlled with the switch is dangerous and must be repaired.
- Disconnect the battery pack from the power tool before making any adjustments, changing accessories, or storing power tools. Such preventive safety measures reduce the risk of starting the power tool accidentally.
- Store power tools out of the reach of children and do not allow persons unfamiliar with the power tool or these instructions to operate the power tool. Power tools are dangerous in the hands of untrained users.
- Maintain power tools. Check for misalignment or binding of moving parts, breakage of parts and any other condition that may affect the power tool's operation. If damaged, have the power tool repaired before use. Many accidents are caused by poorly maintained power tools.

SAFETY INFORMATION

- Keep cutting tools sharp and clean. Properly maintained cutting tools with sharp cutting edges are less likely to bind and are easier to control.
- Use the power tool, accessories and tool bits etc. in accordance with these instructions, taking into account the working conditions and the work to be performed. Use of the power tool for operations different from those intended could result in a hazardous situation.

Service

- Have your power tool serviced by a qualified repair person using only identical replacement parts. This will ensure that the safety of the power tool is maintained.

Special Safety Information for Hedge Trimmers

- Keep all body parts away from the blade. Do not attempt to remove clippings while the blade is operating or to hold on to material which is to be cut. Only remove trapped clippings when the tool is switched off and battery is removed. One moment of carelessness in the usage of the hedge trimmer can lead to severe injury.
- Carry the hedge trimmer by the handle with the blade stopped. Always put on the protective cover during transport and storage of the hedge trimmer. Careful handling of the tool reduces the risk of injury from the blade.
- Hold the power tool only on the insulated handle surfaces, as the cutting blade may come into contact with concealed power cables. Contact between the cutting blade and a live cable may render metallic components live and result in an

SAFETY INFORMATION

electric shock.

- For your personal safety: Wear suitable work clothes such as boots with non-slip soles, sturdy long trousers, gloves and goggles. Do not use this tool while walking barefooted or while wearing open sandals.
- Do not use the hedge trimmer in the rain.
- The appliance is designed for trimming hedges. Do not use to cut twigs, hard wood or other objects.
- Do not attempt to dislodge a blocked/trapped blade before switching the tool off.
- Before commencing with the trimming check the hedge for hidden objects such as wire etc.
- When operating the appliance, always hold it well with both hands and at some distance away from your body.
- Do not use the tool in the vicinity of flammable liquids or gasses. Fire-and explosion risk in the event of a short circuit.
- The blades have to be checked for wear in regular intervals and re-sharpened. Blunt blades will overload the machine. Resulting damages are not covered by warranty.
- Do not attempt to repair the tool yourself, unless you are qualified to do so. All works, which are not described in this manual, may only be performed by a qualified person.
- Ensure that the device is switched off before inserting the battery. Inserting a battery into a power tool that is switched on may result in accidents.
- The device must not be used by people (including children) with limited physical, sensory or mental faculties or who lack the necessary experience and/or knowledge - other than they are supervised by a person responsible for safety

SAFETY INFORMATION

or are being instructed to operate the appliance by such a person.

- Children must be supervised in order to ensure that they do not play with the equipment.

Residual Risks

Even if properly operating and handling this electric tool, some residual risks will remain. Due to its construction and build, this electric tool may present the following hazards:

- Cuts
- Ear damage if working without ear protection.
- Damage to your health caused by swinging your hands and arms when operating the appliance for longer periods of time or if the unit is not held or maintained properly.



WARNING

During operation, this electric tool generates an electromagnetic field which, under certain circumstances, may impair the functionality of active or passive medical implants. To reduce the risk of serious or lethal injuries, we recommend that persons with medical implants consult their doctor and the manufacturer of their medical implant before operating the machine.



WARNING

Before use, check that the blades are sharp. Ensure that the blades are sharpened whenever blunt, in order to avoid overstressing of the machine. Damages caused by cutting with blunt blades are not covered by the guarantee.

SAFETY INFORMATION

Battery Safety Information

- Recharge only with the charger specified by the manufacturer. A charger that is suitable for one type of battery pack may create a risk of fire when used with another battery pack. Incorrect use may result in electric shock, overheating or leakage of corrosive liquid from the battery.
- Do not place appliances or their batteries near fire or heat sources. Continuous intense sunlight, fire or other heat sources may cause an increased danger of explosion.
- Do not crush, drop or damage the battery pack. Do not use a battery pack or charger that has been dropped or received a sharp blow. A damaged battery is subject to explosion. Properly dispose of a dropped or damaged battery immediately.
- Batteries can explode in the presence of a source of ignition, such as a pilot light.
- To reduce the risk of serious personal injury, never use any cordless product in the presence of an open flame. An exploded battery can propel debris and chemicals. If exposed, flush with water immediately.
- Do not charge battery in a damp or wet location. Following this rule will reduce the risk of electric shock.
- For best results, your battery tool should be charged in a location where the temperature is more than 4°C but less than 40°C.
- Under extreme usage or temperature conditions, battery leakage may occur. If liquid comes in contact with your skin, wash immediately with soap and water. If liquid gets into your eyes, flush them with clean water for at least 10

SAFETY INFORMATION

minutes, then seek immediate medical attention.

- When the battery pack is not in use, keep it away from other metal objects like: paper clips, coins, keys, nails, screws, or other small metal objects that can make a connection from one terminal to another. Shorting the battery terminals together may cause sparks, burns, or a fire.
- Do not open up the battery and avoid mechanical damage to the battery. Risk of short circuit and fumes may be emitted. Ensure fresh air and seek medical assistance in the event of discomfort.
- Always remove battery pack before storing the device. When battery becomes fully charged, unplug the charger from the power supply and remove the battery pack from the charger.
- Keep battery pack dry, clean, and free from oil and grease. Always use a dry cloth when cleaning. Never use brake fluids, gasoline, petroleum-based products, or any solvents to clean battery pack.

Charger Safety Information

- Ensure the battery pack is charged indoors only, in a dry, cool and well ventilated environment.
- Do not use non-rechargeable batteries!
- Do not operate the charger with a damaged cord or plug, which could cause shorting and electric shock. If damaged, immediately discontinue use. Replace the charger with the identical unit as listed in the Product Specifications in this manual. If the power cord for this equipment is damaged, it must be replaced by the manufacturer, a customer service

SAFETY INFORMATION

agent of the same or a fully qualified person in order to prevent hazards.

- The plug of the charger must match the outlet. Never modify the plug in any way. Unmodified plugs and matching outlets will reduce the risk of electric shock.
- Allow a hot battery to cool before charging.
- Before each use, check the charger, cable and plug. Do not use a defective charger and do not disassemble the charger. Incorrect reassembly may result in the risk of fire, electric shock or electrocution.
- Protect the charger against moisture and wet conditions. There is a danger of electric shock.
- Operate the charger only with the appropriate original batteries. Charging other batteries may result in injuries and risk of fire.
- Keep the cord away from heat, oil, sharp edges or moving parts. Damaged or entangled cords increase the risk of electric shock.
- Do not use a charger that has been dropped or received a sharp blow.
- The voltage indicated on the charger rating plate must correspond to the voltage of the power source.
- Never touch the mains plug with wet hands

Intended Use

This product is intended for private domestic use only, not for any commercial trade use. It must not be used for any purposes other than those described. Any use of the machine that deviates from its intended use and is not included in these instructions is considered unauthorised use and relieves

SAFETY INFORMATION

the manufacturer from his or her legal liability.

IN THE BOX

1. Rear Handle
2. On/Off Switch, Rear
3. Rear Safety Guard
4. Hand Protection
5. Hedge Trimmer Blade
6. Safety Switch
7. Front Handle
8. On/Off Switch, Front
9. Ventilation Slots
10. Blade Guard
11. Battery Pack
12. Release Button
13. Battery Charger with VDE plug (included in mainland EU products only)
14. Battery Charger with BS plug (included in UK products only)
15. Instruction Manual

ASSEMBLY

Assembly Preparation

- Carefully remove all contents from the product packaging.
- Ensure you have all the accessories and tool(s) needed for assembly and operation. This also includes suitable personal protective equipment.

Installing/Removing the Battery Pack (See Fig. 1)

IMPORTANT! Before using the hedge trimmer, read all safety precautions and follow the instructions in the Battery Pack and Charger section. If storing for a prolonged period of time, remove the battery.



WARNING

Follow these instructions in order to avoid injury and to reduce the risk of electric shock or fire:

- Replace the battery pack or the charger immediately if the battery case or charger cord is damaged.
 - Verify that the switch is in the OFF position before inserting or removing the battery pack.
 - Verify that the battery pack is removed and the switch is in the OFF position before inspecting, adjusting, or performing maintenance on any part of the hedge trimmer.
 - Read, understand, and follow the instructions contained in the section entitled Battery Pack Operation and Charger Operation.
-

To Install the Battery Pack (Fig. 1)

- Align the support rails located on the battery chamber with the guide rails on the battery pack.
- Slide the battery pack fully towards the handle until the latch locks into place. Ensure it is secured.

To Remove the Battery Pack

Press the release button on the battery pack and remove it from the hedge trimmer.

NOTE: The battery pack fits onto the hedge trimmer snugly in order to prevent accidental dislodging.

OPERATION

Battery Pack Operation



WARNING

Use only with 24V Lawnmaster® HYCH0132400500B or HYCH0132400500G battery charger.

The battery charger supplied is specifically designed for the lithium-ion battery used in this garden appliance and may cause risk of fire if used with a non-compatible battery pack.

Check the power voltage! Battery chargers operate on 100-240V AC.

Ensure the battery is charged between 4°C and 40°C. This ensures an optimum battery service life.

Protect the battery from heat, from continuous exposure to sun and keep away from radiation or other heat sources. Do not leave the battery in the hedge trimmer in direct sunlight over long periods. The battery is supplied partially charged. To ensure full capacity of the battery, charge the battery before using your appliance for the first time. The lithium-ion battery can be charged at any time without reducing its service life. Interrupting the charging procedure does not affect the battery.

Charger Operation (See Fig. 2)



WARNING

Use only with 24V Lawnmaster® 24LB2004 or 24LB4005 battery.

If any part of the charger is missing or damaged, do not operate it! Replace the charger with a new one. Failure to pay attention to this warning could result in possible serious injury.

Check the voltage! The voltage must comply with the information on the rating label.

- Align the battery pack to the slots on the charger. Slide the battery pack in until it locks into place (Fig. 2).
- Connect the charger to the power supply.
- After the battery is charged, it is suggested that the charger be disconnected from the power supply.
- Press the release button on the battery pack and remove it from the charger.

NOTE: It is normal for the battery pack and the charger to become warm during charging process. If the battery does not charge properly, check to make sure the electrical outlet is operational. Always charge the battery before storage!

OPERATION

■ Charger LED (①)

- If the battery is not connected to the charger, a **continuous green LED light** indicates that the plug is plugged into an outlet socket and the battery charger is ready for operation.
- Charging: a **continuous red LED** on the charger indicates that the battery is charging normally.
- Charged: a **continuous green LED** on the charger indicates that the battery is ready for use.
- Charging Paused: a **flashing red LED light** on the charger indicates that charging is paused. Battery temperature is not within the charging temperature range of 4°C and 40°C or the charging voltage is too low. As soon as the permitted temperature is reached, the battery charger will automatically switch to charging.
- After continuous or repeated charging cycles without interruption, the charger may warm up. This is normal and does not indicate a technical defect of the battery charger.

The indicator lights on the charger show the charger status:

INDICATOR LIGHT	STATUS
Red, continuous	Charging
Green, continuous	Fully charged / Connected to power supply (Standby)
Red, flashing	Charging paused

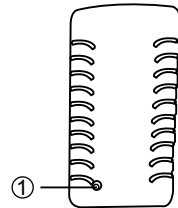

Starting / Stopping the hedge Trimmer (See Fig. 3 & 4)

WARNING

Wear suitable clothing and work gloves when working with the equipment. Ensure that the equipment is functional before each use. The on/off switch and the safety switch must not be held closed. They must switch off the motor when on is released. Should a switch be damaged, stop working with the equipment.

WARNING

After turning off the appliance, the blades will keep moving for some time. Allow the blades to come to a standstill. Neither touch nor slow down the moving blades. Risk of injury!

WARNING

Ensure that you are standing in a firm position with both hands gripping the hedge trimmer away

OPERATION

from the body. Ensure that the hedge trimmer is in contact with no other objects before switching on.

This hedge trimmer features a two-hand power switch to ensure safe starting.

- Make sure that the battery is installed properly.
- Carefully remove the blade guard from the hedge trimmer blade (Fig. 3).
- Press the safety switch at the front handle (Fig. 4).
- Press the front and rear On/Off switches. The hedge trimmer will run at top speed (Fig. 4).
- To turn the hedge trimmer off simply release the front or rear On/Off switch.

General Operation

- Check the product, its battery pack and charger as well as accessories for damage before each use. Do not use the product if it is damaged or shows wear.
 - Always hold the product by its handles. Keep the handles dry to ensure safe support.
 - Ensure that the air vents are always unobstructed and clear. Clean them if necessary with a soft brush. Blocked air vents may lead to overheating and damage the product.
 - Switch the product off immediately if you are disturbed while working by other people entering the working area. Always let the product come to complete stop before putting it down.
 - Do not overwork yourself. Take regular breaks to ensure you can concentrate on the work and have full control over the product.
-

WARNING

To avoid personal injury:

- Handle the blade with care.
 - Do not place your fingers or hand between the notches in the blade or in any position where they could get pinched or cut.
 - Never service the blade or hedge trimmer unless the battery pack is removed.
 - Do not use if the blade assembly is damaged or bent. Take hedge trimmer to a qualified service dealer for blade replacement using identical parts as specified in the Parts List of this manual.
 - Always keep both hands on the hedge trimmer handles to prevent your hand from touching the blade.
-

OPERATION

Trimming (See Fig. 5 & 6)

- Using a pruning tool to cut and remove branches exceeding the cutting width capacity of this product of 15 mm before operation.
- Move the hedge trimmer lightly through the cutting surface in a sweeping motion following the shape of the hedge or shrub.
- A slight tilt downwards of the hedge trimmer in the direction of motion is recommended for optimum cutting performance.
- Do not rush and do not attempt to cut too much with one stroke of the hedge trimmer.
- First cut both sides of the hedge from the bottom cutting upwards to the top. This will prevent any of the trimmings falling into the path of the area still to be cut (Fig. 5).
- After cutting the hedge sides proceed to the top (Fig. 6).

MAINTENANCE



WARNING

When servicing, use only recommended replacement parts. Use of any other parts may create a hazard or cause product damage.



WARNING

To avoid serious personal injury, always remove the battery pack from the tool when cleaning or performing any maintenance.



WARNING

Wear safety gloves when working on the cutting device and close to it. Use appropriate tools to remove debris e.g. a brush or wooden stick. Never use your bare hands.

General Maintenance

- Keep all safety devices, air vents and the motor housing free of dirt and dust. Avoid using solvents when cleaning plastic parts. Most plastics are susceptible to damage from various types of commercial solvents and may be damaged by their use. Use clean, dry cloths to remove dirt, dust, oil, grease, etc.
- Remove any buildup of grass and leaves on or around the motor cover. Wipe the hedge trimmer with a dry cloth occasionally. Do not use water as this may damage any electrical components.
- To store the hedge trimmer, remove the battery pack from the hedge trimmer.
- Always place the guard on the blade before storing or transporting the hedge trimmer. Use caution to avoid the sharp teeth of the blade.
- Store the hedge trimmer indoors, in a dry, well-ventilated place that is inaccessible to children.

Cleaning the Blade

- Remove the battery pack.
 - Keep the cutting blades clean and free of debris.
 - Use a brush or high pressure air (max. 3 bar) to remove debris from the blades.
 - With gloves on, clean the blades with a dry cloth to remove loose material.
 - Apply a small amount of light machine oil to the edge of the top blade to retain good cutting performance. See Lubricating the Blade section.
 - Keep the cutting blades sharp. Have heavily worn or damaged blades replaced with identical parts by a qualified service dealer.
 - Adjustment of the distance between blades is not necessary, as this is predetermined by the manufacturer.
-

MAINTENANCE

Lubricating the Blade

WARNING

Always allow the blades of the hedge trimmer to come to a stop and remove the battery pack before lubricating. Failure to do so could result in accidental starting causing possible serious personal injury.

For easier operation and longer blade life, lubricate the hedge trimmer blade before and after each use.

- Stop the hedge trimmer and remove the battery pack from the hedge trimmer.
- Lay the hedge trimmer on a flat surface. Apply light machine oil along the edge of the top blade.

NOTE: If you will be using the hedge trimmer for an extended time, it is advisable to oil the blade periodically.

Battery and Charger Maintenance

- Keep the battery and charger clean and clear of debris. Do not allow foreign material into the recessed cavity or on the contacts. Wipe with a dry cloth. Do not use solvents, water, or place in wet conditions.
 - Always unplug the charger when there is no battery pack in it.
 - Check that the charger and battery contacts have not been shorted by debris or foreign material. Always store away from metal objects which could create a connection with the terminals.
 - Always remove the battery when storing the hedge trimmer and keep in a cool dry place out of direct sunlight.
 - Store the battery only within a temperature range between 0°C and 25°C and do not subject or store the battery pack to direct sunlight.
 - It is recommended to store the lithium-ion battery pack in a 30%-50% charged condition.
 - It is recommended to fully charge the lithium-ion battery pack after every six months of storage.
-

TROUBLESHOOTING

WARNING

ONLY PERFORM THE STEPS DESCRIBED WITHIN THESE INSTRUCTIONS!

WARNING

REMOVE THE BATTERY PACK BEFORE TROUBLESHOOTING.

PROBLEM	POSSIBLE CAUSE	SOLUTION
Appliance won't start.	Battery is discharged.	Recharge the battery.
	Battery not in the hedge trimmer.	Insert the battery.
	Safety switch is not pressed properly.	Turn on the hedge trimmer. Refer to Starting / Stopping the Hedge Trimmer section in this manual.
	On/Off switch is defective.	Contact Aftersales Helpline.
Intermittent operation.	Internal loose contact.	Contact Aftersales Helpline.
	On/Off switch is defective.	
Blades become hot.	Blades are blunt.	Have the blades sharpened or replaced.
	Blades are notched.	Have the blades checked or replaced.
	Too much friction due to the lack of lubrication.	Oil the blades.
Quality of cut is poor.	Too much friction due to the lack of lubrication.	Lubricate the hedge trimmer blade.
	Hedge trimmer blade is dirty.	Clean the hedge trimmer blade.
	Hedge trimmer blade is blunt.	Sharpen or have hedge trimmer blade replaced.
	Cutting technique is bad.	Refer to Trimming section in this manual.
	Battery is not fully charged.	Recharge the battery.
Charging is not possible.	Battery is too warm.	Allow the battery to cool.
	Battery is not placed in battery charger properly.	Insert battery correctly.
	Battery charger is not plugged into mains properly.	Plug into mains outlet correctly.
	Battery contacts dirty.	Clean the contacts.
	Battery is defective.	Replace the battery.
	Battery charger is defective.	Replace the battery charger.

TECHNICAL DATA

24V Cordless Hedge Trimmer

Type	Cordless, Battery-powered
Motor	24V \equiv
Cutting Device	Dual-Action Reciprocating Blades
Maximum Branch Cutting Width	15mm
Cutting Bar Length	520mm
Sound Pressure Level (L_{PA})	78dB(A) K=3dB
Sound Power Level (L_{WA}) Guaranteed	101dB(A)
Sound Power Level (L_{WA}) Measured	98dB(A) K=3dB
Vibration (a_v)	2.5m/s ² K=1.5m/s ²
Weight (Without 2.0Ah Battery)	2.2kg

CHARGER

Model No.	HYCH0132400500B (with BS Plug, included in UK products only)
	HYCH0132400500G (with VDE Plug, included in mainland EU products only)
Charger Input	100-240V ~ 50/60Hz 0.32A
Charger Output	24V \equiv 0.5A
Charging Period (Battery Fully Discharged)	3-5H (For 24LB2004)
Weight of Charger	0.2kg
Insulation Protection of Charger	<input type="checkbox"/>

BATTERY

Model No.	24LB2004
Rated Voltage of Battery	24V \equiv
Capacity of Battery	2.0Ah
Battery Type	Lithium-Ion
Weight of Battery	0.41kg

RECYCLING AND DISPOSAL



This marking indicates that this product should not be disposed with other household wastes throughout the EU. The machine must be delivered in rigid packaging to avoid damage during transportation. The packaging and the machine itself are manufactured from recyclable materials and should be disposed of accordingly.



This appliance contains Lithium-ion battery. Do not dispose of batteries in household waste, fire or water. Dispose of batteries in accordance with the local regulations where they will be recycled in an environmentally friendly manner.

Li-ion

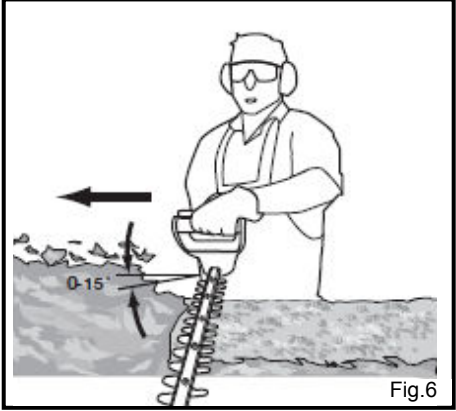
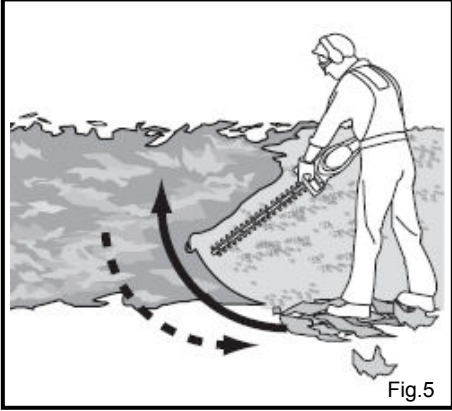
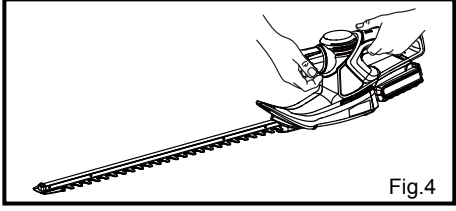
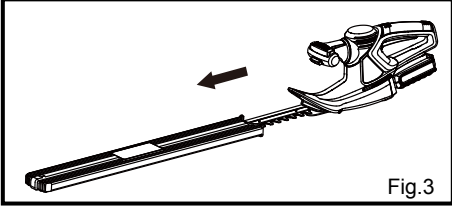
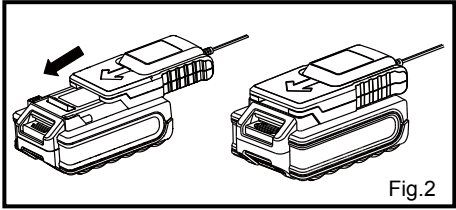
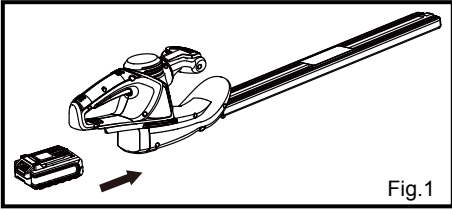

CLHT2452
Suzhou Cleva Electric Appliance Co. Ltd
8 Ting Rong Street,
Suzhou Industrial District
215122 Suzhou, Jiangsu Province, P.R.C
www.cleva-europe.com