

Garden **///TEK**

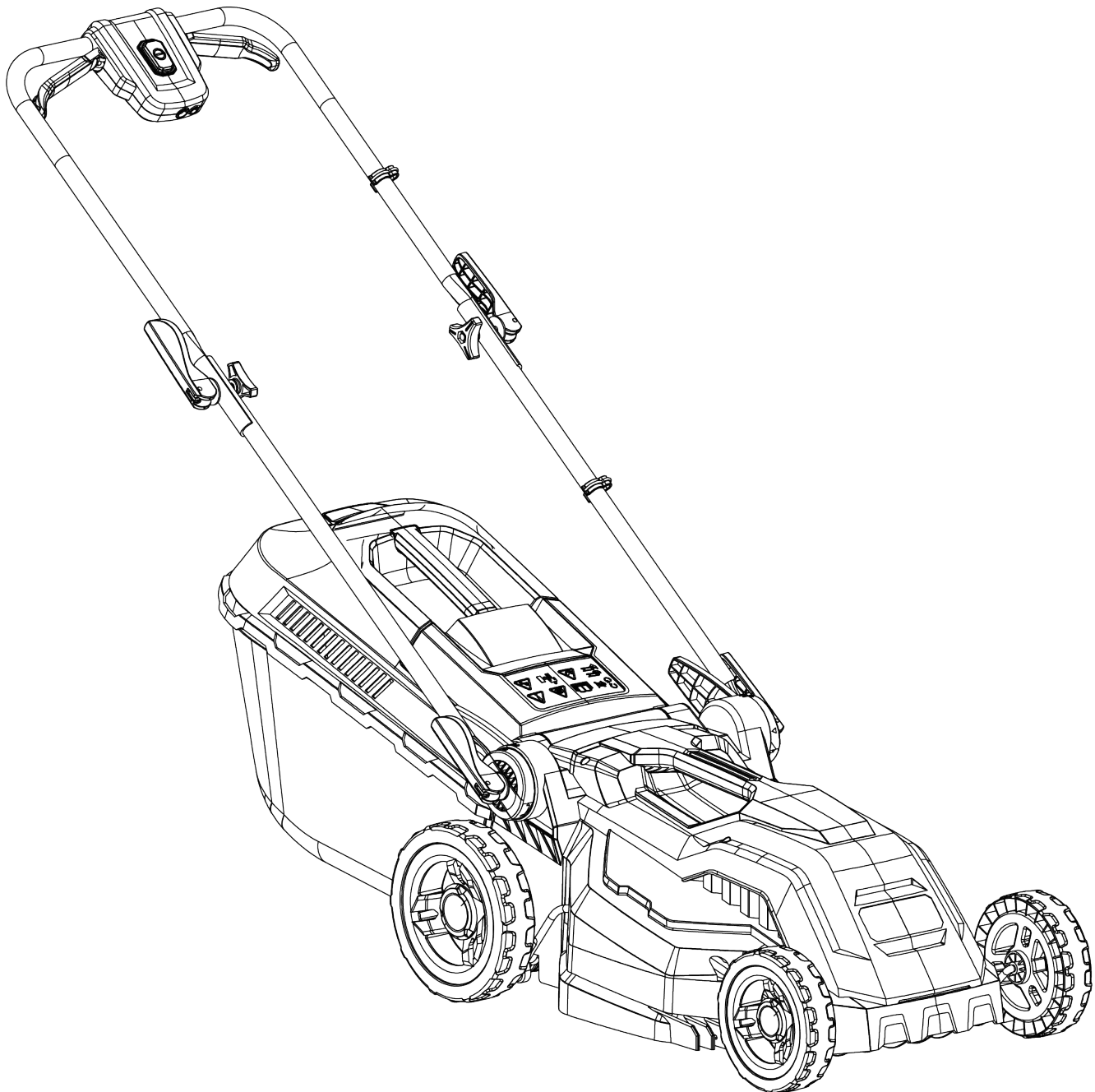

ELECTRIC CORDED LAWNMOWER GT38E

Instruction Manual



Introduction

Thank You For Purchasing Your GardenTek Product

We work very hard to give all of our customers the best possible service. If you have any problems, before leaving negative feedback, please contact us to give us a chance to resolve the issue. We would be delighted if you left us positive feedback! Thank you for purchasing this product.

Important!



⚠WARNING : READ THE INSTRUCTION BOOKLET THOROUGHLY BEFORE USING THE MACHINE. Keep for future reference and pass it on if the machine is loaned or sold to another user.

This manual has been produced by GardenTek and should be kept with the product. Please read and understand these instructions before you use your product. Failure to do this may result in personal injury or damage to the product.

The safety precautions and warnings are to ensure your safety and protect you from harm or damage to the product.

The information contained in this manual was accurate at the time of production, however GardenTek may make modifications to the product without notification.

Contents

| | | | |
|------------------------------------|--------------|---------------------------------------|-----------|
| Safety Information..... | 4-15 | Technical Data..... | 34 |
| Understand Your Machine..... | 4 | Recycling And Disposal..... | 35 |
| Personal Safety..... | 5 | Declaration Of Conformity..... | 36 |
| Inspect Your Machine..... | 6 | Useful Information..... | 37 |
| Work Area..... | 7 | Our YouTube Channel..... | 37 |
| During Use..... | 8-9 | Warranty..... | 37 |
| Batteries..... | 10 | Manual Updates..... | 37 |
| Electrical Safety..... | 11 | Returning Your Product..... | 37 |
| Vibrations..... | 12 | Leaving A Review..... | 37 |
| Noise..... | 12 | Ordering Spare Parts..... | 37 |
| Personal Protective Equipment..... | 13 | Product Information..... | 38 |
| Intended Use..... | 14 | Contact Us..... | 39 |
| Symbols On The Machine..... | 15 | | |
| Features..... | 16-17 | | |
| Unboxing..... | 18 | | |
| Assembly..... | 19-22 | | |
| Assembly Safety..... | 19 | | |
| Lower Handle Assembly..... | 20 | | |
| Upper Handle Assembly..... | 21 | | |
| Assembling Grass Collector..... | 22 | | |
| Cable Hook..... | 22 | | |
| Operation..... | 23-26 | | |
| Grass Collection..... | 23 | | |
| Mulching..... | 24 | | |
| Cutting Height Adjustment..... | 25 | | |
| Rear Roller..... | 25 | | |
| Starting / Stopping..... | 27 | | |
| Maintenance..... | 28-33 | | |
| Maintenance Safety..... | 28 | | |
| Checking Your Machine..... | 28 | | |
| Cleaning..... | 29 | | |
| Transportation..... | 30 | | |
| Storage..... | 31 | | |
| Blade Maintenance..... | 32 | | |
| Wheels..... | 33 | | |
| Troubleshooting..... | 33 | | |

Safety Information

▲ Safety

No list of safety guidelines can be complete. Every environment is different. Always consider safety first, as it applies to your individual working conditions. Use this and other machinery with caution and respect. Failure to do so could result in serious injury, damage to equipment, or poor work results.

Some or all of the following - warning signs and symbols may appear throughout this manual. You **MUST** adhere to their warnings. Failure to do so may result in personal injury to yourself or those around you.

▲ DANGER

Indicates a hazard, which, if not avoided, could result in serious injury or death.

▲ WARNING

Indicates a hazard, which, if not avoided, could result in serious injury.

▲ CAUTION

Indicates a hazard which, if not avoided, might result in minor or moderate injury.

▲ Understand Your Machine

- **WARNING!** You must read these instructions carefully before operating the machine. Make sure that you are familiar with the controls and properly operate the machine. You must learn how to stop the machine quickly. If you do not follow the warnings and instructions, it may result in fire and/or serious injury. Make sure to save all warnings and instructions for future reference.
- Read this manual and labels affixed to the machine to understand its limitations and potential hazards.
- Be thoroughly familiar with the controls and their proper operation. Know how to stop the machine and disengage the controls quickly.
- If the unit is to be used by someone other than original purchaser, or is to be loaned, rented, or sold, always provide this manual and any needed safety training before operation. The user can prevent and is responsible for accidents or injuries that may occur to themselves, to other people, or to property.
- Do not force the machine beyond its limits. Use the correct machine for your application.
- Know how to stop the machine quickly in case of emergency. Understand the use of all controls.
- ALL MAINTENANCE other than that listed in this manual, should be carried out by professionally trained and certified personnel.
- When using this machine for the first time and before actual work, you **MUST** learn how to handle the machine from an experienced or skilled person.

Safety Information

⚠ Personal Safety

- **WARNING!** Never allow children or people unfamiliar with these instructions to use the product. Local regulations can restrict the minimum age of the operator.
- Keep children, pets, and other people not using the unit away from the work area (at least 15m). Be alert and shut off the unit if anyone enters work area. Keep children under the watchful care of a responsible adult.
- Stay alert, watch what you are doing and use common sense when operating the machine. Never operate the machine when unwell or tired, or if you have taken alcohol, medicine, drugs or any substances which may slow your reflexes and compromise judgment. A moment of inattention while operating the machine may result in serious personal injury.
- Appropriate Personal Protective Equipment (PPE), **MUST** be worn at all times when operating or repairing the machine. Always wear anti-slip and resistant work footwear and long trousers while using the machine. Do not use the machine when barefoot, wearing sandals or similar lightweight footwear. Do not wear chains, bracelets or clothing that is loose fitting or hanging ties or cords. Tie long hair back. Always wear protective earplugs. Loose clothes, jewellery, or long hair can be caught in moving parts. Protect eyes, face, and head from objects that may be thrown from the unit. Always wear safety goggles or safety glasses with side shields when operating.
- Always keep hands and feet away from all moving parts during operation. Moving parts can cut or crush body parts. Always keep hands and feet away from all pinch points.
- Do not touch parts that might be hot from operation. Allow parts to cool before attempting to maintain, adjust, or service.
- Do not overreach. Keep proper footing and balance at all times. This enables better control of the machine in unexpected situations. Extending your body too far can result in a loss of balance and you may fall which will result in injury.
- Never place any part of your body where it would be in danger if movement should occur during assembly, installation, and operation, maintenance, repairing or moving.
- Start the machine carefully according to instructions and with feet away from the moving parts.
- Do not place your hands or feet near or under rotating parts. Keep away from any discharge openings.
- Keep in mind that the operator or user is responsible for accidents, hazards or unexpected events involving the machine that occur to other people or their property. It is the responsibility of the user to assess the potential risk of the area where work is being carried out. The operator or user must take all necessary precautions to ensure their own safety and that of others, especially on slopes or rough, slippery and unstable ground.

Safety Information

▲ Inspect Your Machine

- Check your machine before starting it. Keep guards in place and in working order. Make sure all nuts, bolts, etc., are securely tightened.
- You must check the general condition of the machine before use.
- Never operate the machine when it is in need of repair or is in poor mechanical condition. Replace damaged, missing, or failed parts before using it. Keep the machine in safe working condition.
- Do not use the machine if the switch does not turn off the machine when running.
- Regularly check to see that keys and adjusting wrenches are removed from the machine area before starting it. A wrench or a key that is left attached to a rotating part of the machine may result in personal injury.
- If the machine should start to vibrate abnormally, stop the machine and check immediately for the cause. Vibration is generally a warning sign of trouble.
- Avoid accidental starting. Be sure the machine's switch is off before transporting the machine or performing any maintenance or service on the unit. Transporting or performing maintenance or service on a machine with its switch on invites accidents.
- Do not tamper with or disable safety systems.
- Only use manufacturer-recommended attachments.
- Before using, always visually inspect to see that the tools are not worn out or damaged. Replace worn out or damaged elements and bolts in set to preserve balance.
- Keep the machine in good operating condition. Operating the machine in poor or questionable condition could result in serious injury.
- Be sure all safety devices are in working order and warning labels are in place. These items are installed for your safety.

Safety Information

▲ Work Area

- Make sure you thoroughly inspect the entire work area and remove all objects and anything that could be thrown by the machine or could damage the machine (branches, stones, wire, toys, etc). Attempting to clear the work area whilst using the machine will reduce your concentration and creates a trip hazard. Any liquid spilled on the floor may result in you slipping.
- You must only work in daylight or with good artificial light in good visibility conditions. Do not work at night, at times of heavy fog, or at any other times when your field of vision might be limited and it would be difficult to gain a clear view of the area.
- Keep people, children and animals away from the working area.
- Operate on flat, level ground.
- DO NOT work on wet ground. If there has been heavy rain on the working site, wait until the ground has dried up.
- You must pay special attention when approaching obstacles that could compromise visibility.
- Exercise extreme caution when changing direction on slopes. When changing direction, you need to be careful that the wheels do not hit any obstacles (such as roots, branches, stones, etc) that can cause the machine to slide sideways or make you lose control of it. Avoid driving on slopes steeper than 15%. Make sure on slopes you have a steady foothold.
- Find and locate all fixed objects in the ground, such as sprinkler systems, poles, water valves, bases for washing lines etc. Make sure that you check for hidden electrical cables or similar on the surface of the lawn. ALWAYS run the machine around these objects. NEVER intentionally run the machine over foreign objects.
- Never park the machine in a place with unstable ground which could give way.
- You must be careful near ravines, ditches or embankments.
- Exercise extreme caution when operating on or crossing gravel drives, walks, or roads. Stay alert for hidden hazards or traffic.
- Pay the utmost attention when working on frozen ground as the machine may tend to skid.
- Do not work in the rain, when there is a thunderstorm or lightning risk, at times of strong or gale force winds, or at any other times when the weather conditions might make it unsafe to use this product. If there is bad weather conditions, do not use the machine.

Safety Information

⚠ During Use

- Always hold the unit with both hands when operating. Keep a firm grip on the handlebars. Be aware that the machine may unexpectedly bounce upward or jump forward if the machine should strike buried obstacles such as large rocks or roots.
- Do not operate the machine in confined areas where there may be a risk of crushing the operator between the machine and another object.
- Walk, never run with the machine. Be very careful when pulling the machine toward you. You must look behind you to make sure there are no obstacles before and during operations in reverse gear (if applicable). Do not allow the machine to pull you along.
- **WARNING!** If something breaks or an accident happens whilst working, you must turn off the machine immediately and move the machine away to prevent further damage. If an accident happens with injuries or third parties are injured, carry out the first aid measures most suitable for the situation immediately and contact the medical authorities for any necessary health care. Carefully remove any debris that might cause damage or harm persons or animals should it not be seen.
- Use extreme caution when reversing or pulling the machine backwards.
- Do not carry passengers.
- Never operate the machine at a fast pace.
- The excessive speed of movement or the absence of maintenance have a significant influence on noise emissions and vibrations. It is necessary to take preventive steps to eliminate possible damage due to high levels of noise and stress from vibration. You must maintain the machine well, wear ear protection and take breaks from working.
- After striking a foreign object, stop the machine immediately and inspect the machine thoroughly for damage. Repair the damage before continuing.
- Never attempt to make any adjustments, while the machine is running.
- Never attempt to move the machine in any way other than intended for normal use while the machine is running.
- Factory-fitted control devices, such as the handle-mounted clutch cable, must not be removed or exposed.

Safety Information

⚠ During Use (Continued)

- You must disengage the blade, switch off the machine and disconnect from the power supply (making sure that all moving parts are stationary):
 - Before adjusting the cutting height.
 - After striking a foreign object, you must inspect the machine for damage and make repairs before using it again.
 - Before checking or working on the machine.
 - Before clearing blockages.
 - When transporting the machine.
 - Whenever you leave the machine unattended.
 - When crossing surfaces other than grass.
 - Before emptying the grass collector.
 - Before changing the cutting height.

Safety Information

⚠ Batteries (Where Present)

Batteries present a risk if they become damaged by the possible leaking of electrolyte. This electrolyte is an acid and can cause serious burn injuries. Care should be taken when working on or near them. **NOTE** the electrolyte may be in a liquid or gel form.

Should you come in to contact with electrolyte you should;

- Remove all clothing contaminated with electrolyte. If you cannot remove then saturate them in water.
- Get medical assistance as soon as possible.

You must advise the medical staff of the type of acid.

- Lead/acid battery = dilute sulphuric acid.
- Nickel/cadmium = potassium hydroxide alkali electrolyte.
- Use fresh running water to wash off excess electrolyte, continue this until medical assistance arrives. Make sure that you do not wash the electrolyte to another part of your body or face.
- If electrolyte comes in to contact with Eyes the electrolyte needs to be immediately washed away with large amounts of water. Make sure that you do not wash the electrolyte to another part of your face or body.
- Gasses from charging batteries are highly flammable and great care should be taken to charge in well ventilated areas.
-  There is an explosion risk if the battery terminals are short circuited, when connecting/disconnecting ALWAYS exercise great care so that the terminals or battery leads are NOT allowed to touch and cause a spark. ALWAYS use suitable insulated tools.

Safety Information

⚠ Electrical Safety



DANGER!
ELECTRICITY CAN KILL - NEVER WORK ON LIVE/ENERGISED EQUIPMENT.

- Prior to carrying out any maintenance work you **MUST** identify electrical isolation methods and isolate all electrical supplies.
- Prior to use and with all electrical supplies isolated, you **MUST** check all electrical cables, plugs and connectors for the following;
 - Are intact and have no signs of damage, to include but not limited to bare wires, chaffing, cuts and loose wiring.
 - If there are any signs of damage, the damaged item **MUST** be taken out of service until the damage has been repaired by an electrically competent person.
 - All trailing cables should be routed so as not to cause any kind of trip hazard.
 - **NEVER** work on or near electricity with wet hands, wet clothing and wet gloves.
- Power tools plug must match the outlet. Never modify the plug in any way. **DO NOT** use any adapter plugs with earthed (grounded) power tools. Unmodified plugs and matching outlets will reduce risk of electric shock.
- **DO NOT** expose this power tool to rain or wet conditions. Water entering a power tool will increase the risk of electric shock. **DO NOT** abuse the power cord. Never use the cord for carrying, pulling or unplugging the power tool. Keep the cord away from heat, oil and sharp edges or moving parts. Damaged or entangled cords increase the risk of electric shock. When operating a power tool, use an extension cord suitable for outdoor use. Use of a cord suitable for outdoor use reduces the risk of electric shock.
- **IMPORTANT:** Make sure that the electric circuit is fused, and that the power, voltage and frequency of the motor is supported by your mains supply. Also, make sure that your power supply is earthed. Connect your lawnmower to earth. Never open the ON/OFF switchbox. However, if it should become necessary to do so, contact a qualified electrician. Make sure that you will never touch live contacts, specifically when you plug or unplug your lawnmower. This machine and its power cord must never get into contact with water.
- Never use its power cord to move/shift your lawnmower. Always unplug the power cord before handling your lawnmower. Do not pull the plug out of the wall socket by the cable and protect the latter against heat sources, oil and objects which can damage it.
- Avoid body contact with earthed or grounded surfaces such as pipes, radiators, ranges and refrigerators. There is an increased risk of electric shock if your body is earthed or grounded.

Safety Information

⚠ Vibrations (Where Applicable)

- Prolonged use of hand held (operated) machines will cause the user to feel the effects of/from vibrations. These vibrations can lead to white finger (Raynaud's phenomenon) or carpal tunnel syndrome. This condition reduces the ability of the hand to feel and regulate temperature, causing numbness and heat sensations and may cause nerve damage and circulatory tissue death.
- Not all factors that lead to white finger disease are known, but cold weather, smoking and other diseases that affect blood vessels and blood circulation as well as large and long-lasting impact of shocks are considered factors in the formation of white finger. Note the following to reduce the risk of white finger and carpal tunnel syndrome;
 - Wear gloves and keep your hands warm.
 - Take regular breaks.
 - All of the above precautions may help reduce the risk of white finger disease but not rule out the carpal tunnel syndrome. Long-term and regular users are therefore recommended to observe the condition of your hands and fingers. Seek medical attention immediately if any of the above symptoms should occur.

⚠ Noise (Where Applicable)

- The operating noise of the machine can damage your hearing. When wearing protection such as earplugs or ear defenders to protect your hearing. Long-term and regular users are advised to have hearing checked regularly. Be especially vigilant and cautious when wearing ear protection because your ability to hear alarm warnings will be reduced.
- Noise emissions for this equipment is unavoidable. Carry out noisy work at approved times and for certain periods. Limit the working time to a minimum. For your personal protection and protection of people working nearby it is also advisable for them to wear hearing protection.



- See Certificate of Conformity section for Outdoor Noise declaration of conformity.

Safety Information

⚠ Personal Protective Equipment

Appropriate Personal Protective Equipment (PPE), **MUST** be worn at all times when operating or repairing the machine. No protective equipment can ensure 100% protection.

When selecting PPE, make sure it's CE marked and it suits the user in terms of size, fit, etc. If more than one item of PPE is worn at the same time, make sure they can be used together, e.g. wearing safety glasses may disturb the seal of a respirator, causing air leaks.



HAND PROTECTION MUST BE WORN

Protective electrically non-conductive gloves are highly recommended when working.



FOOT PROTECTION MUST BE WORN

Non-skid heavy duty footwear are highly recommended when working.



HEARING PROTECTION MUST BE WORN

Suitable safety hearing protection is recommended.



EYE PROTECTION MUST BE WORN

Always wear safety glasses/goggles and/or face shields. Everyday eyeglasses have only impact resistant lenses; they are not safety glasses/goggles.



PROTECTIVE CLOTHING MUST BE WORN

Do not wear loose clothing, gloves, scarfs, neckties or jewellery (rings, wrist watches), which can be caught in moving parts.



HEAD PROTECTION MUST BE WORN

Wear a safety helmet with a safety visor.



FACE SHIELD MUST BE WORN

Wear a face shield to protect your face.



RESPIRATOR MUST BE WORN

Wear a respirator.

Safety Information

Intended Use

The GT38E is an electric lawnmower from GardenTek. The GT38E has a cutting width of 380mm and is powered by a 1600W motor.

This machine is a garden tool and precisely a pedestrian controlled lawnmower. The operator is able to operate the machine and use the main controls, always staying behind the handle at a safe distance from the rotating blade.

The machine is manufactured according to the latest safety requirements. Every precaution is only effective when it is followed exactly.

Intended Use

This machine was designed and manufactured for cutting (and collecting) grass in gardens and grassy areas, in areas in proportion to its cutting capacity, controlled by a pedestrian operator.

User Types

This machine is intended for use by consumers, i.e. non professional operators. The machine is intended for "DIY" and domestic use only.

Improper Use







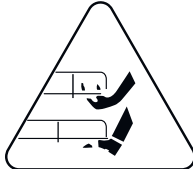

Any other usage not in keeping with the above mentioned ones may be hazardous and harm persons and/or damage things. Examples of improper use may include, but are not limited to:

- transporting people, children or animals on the lawnmower
- letting yourself be transported by the lawnmower
- using the machine to tow or push loads
- using the machine for leaf or debris collection
- using the machine to trim hedges, or cutting anything other than grass
- use of the machine by more than one person
- using the blade on surfaces other than grass

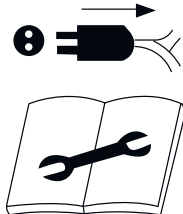
Safety Information

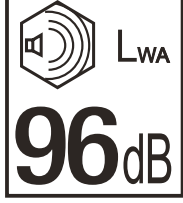
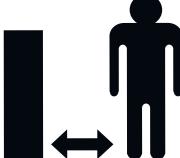
Symbols On The Machine

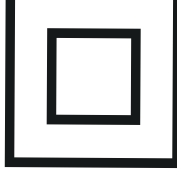
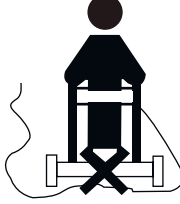
We have provided safety messages in this manual and on the machine. This information alerts you to potential hazards that could hurt you or others. Please read these messages carefully. However, we may not have listed all of the possible hazards, you must also use your own judgment.

| | |
|--|---|
|  <p>IMPORTANT Please read this instruction manual carefully, especially the safety warnings marked with the symbol.</p> |  <p>DANGER! Keep hands and feet away from cutting parts.</p> |
|  <p>INSTRUCTION MANUAL Read and understand operator's manual before using the machine. Failure to follow instructions could result in death or serious injury.</p> |  <p>UNPLUG FROM MAINS Always switch the machine off and unplug from the mains when the unit is left unattended and when carrying out maintenance.</p> |
|  <p>SAFETY DISTANCE Do not put hands or feet near or under rotating parts. Keep a 15 metre safety distance.</p> |  <p>IMPORTANT Acoustic power level.</p> |
|  <p>BYSTANDERS Never allow any bystanders in front of the unit. Keep a 15 metre safety distance.</p> |  <p>WEEE SYMBOL Waste electrical products should not be disposed of with household waste. Please recycle where facilities exist. Check with your local authority or local store for recycling advice.</p> |
|  <p>DANGER! Risk of electric shock.</p> |  <p>PROTECTION CLASS II Equipped with enhanced or double insulation.</p> |
|  <p>DANGER! Do not mow over the cable.</p> |  <p>CE SYMBOL This product complies with the applicable European directives and an evaluation method of conformity for these directives was done.</p> |

Features

GT38E Features



Features

GT38E Features

- 1 Main Handle**
Hold onto with both hands this whilst using the machine.
- 2 On / Off Button**
- 3 Operator Presence Control (OPC) Lever**
This is a safety feature. The machine will stop if you let go of this lever.
- 4 Quick Release Handle**
- 5 Wheel**
- 6 Grass Collector**
- 7 Mulching Plug**

Unboxing

⚠ Unboxing Safety

⚠ WARNING! Unboxing and assembling the machine should be done on a flat, stable surface with enough room. Disposal of the packaging should be done in accordance with the local regulations in force.

⚠ WARNING! Some of the packaging material may be harmful to children. Keep out of reach of children.

Carefully remove the product from the packaging and examine it for any sign of damage caused during shipping. Lay the contents out and check them. If any part is damaged or missing, you must not use the machine. Contact us immediately. You must keep the packaging material in case the machine needs to be returned or repaired.

Ensure that you have all the accessories and tools you need for assembly and operation including the suitable personal protective equipment.

Box Contents

- GT38E Lawnmower
- User Manual
- 40L Grass Collector
- Mulching Plug
- Cable Clips
- 2 x Quick Release Handle Bolts With Washers And Thumbscrew Nuts

Assembly

⚠ Assembly Safety

⚠ CAUTION - This guide is meant to serve as a quick reference for operating your machine. We always advise reading the manual in full before operation.

⚠ NOTE - Images may vary depending on model.

⚠ NOTE - The machine may be supplied with some parts already assembled. Prior to assembly, check all items have been received. The mulching plug may already be installed for transport.

We recommend that you fill out the product information in the back of this manual. If you need to contact an authorised dealer or customer service for information on servicing, you may need to provide this information.

Assembly

Step 1 : Setting The Position Of The Lower Handles

- 1 Unfold the grey arm of the lower handle.
- 2 Line up the arrow with one of three lines to set user height of handle.
- 3 Fold black quick release clamp over to lock the handle position.

Image 1



Image 2

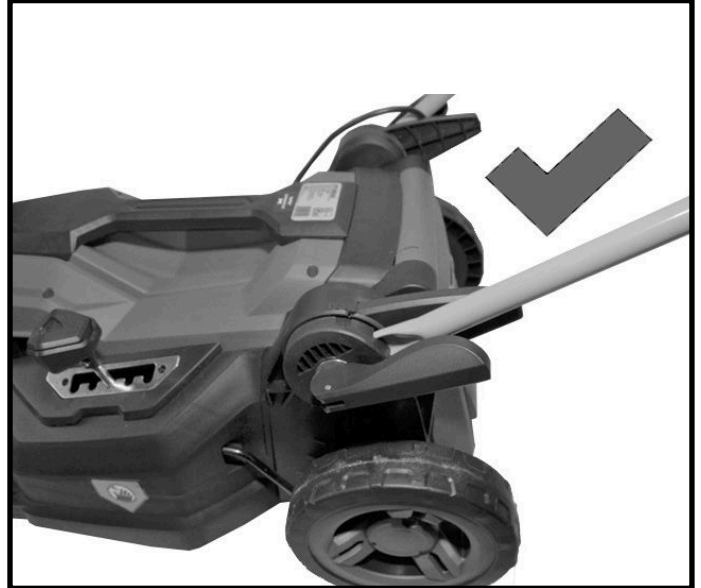

- 4 If the handle is too loose, unfold the quick release clamp and turn clockwise a couple of turns. Fold clamp in again to check tightness.
- 5 If the clamp is too tight, unfold and unscrew anticlockwise a couple of turns.

Assembly

Step 2 : Fixing Upper Handle

- 1 Take the upper quick release clamps from the bag and remove the thumbscrew nut and washer. Make sure Upper Handle is the correct way up with red Start Button on top.
- 2 Pass the clamp bolt through the upper handle hole from the outside. Then pass through the lower handle hole. Fit the washer and nut on the inside of the handle.



- 3 With the clamp closed, tighten the thumbscrew to lock the handle. You can then use the quick release clamp to loosen upper handle and fold over handle for storage.
- 4 Fit the two cable clips to retain black cable from the handle to the motor.

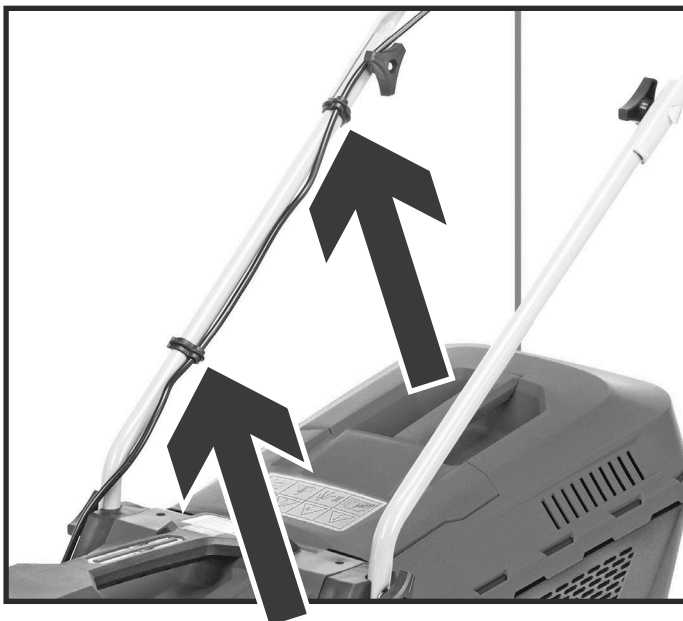

Assembly

Step 3 : Assembling Grass Collector

- 1 You will need to clip the edge of the bag around the frame of the collector.

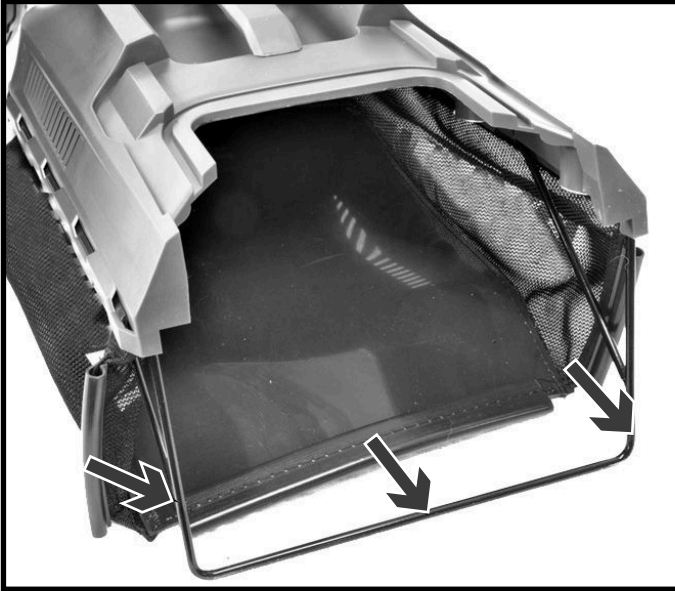

Step 4 : Cable Hook

- 1 Loop the orange cable into the retaining hook. Leaving enough slack between the hook and the switch unit.

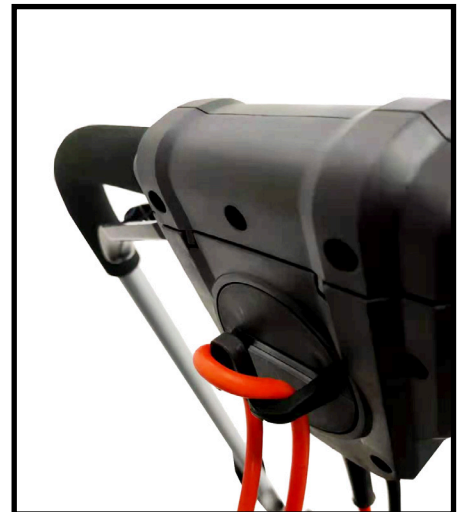
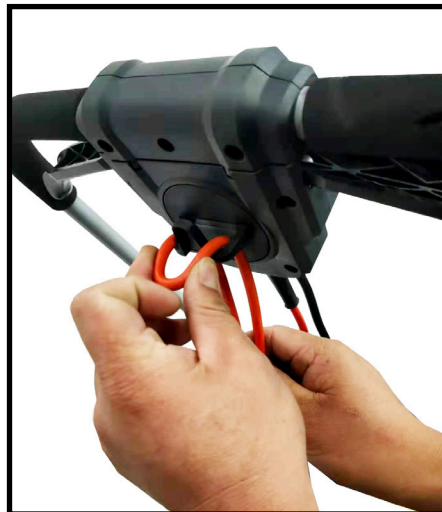
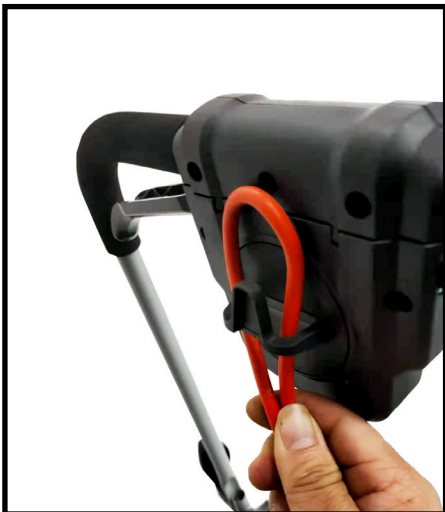

Operation

Grass Collection

- 1 To fit the grass collector to the mower, lift the rear flap and attach onto the hooks.
- 2 Only remove the grass collector with the mower switched off.
- 3 There is an indicator on the rear of the grass collector which shows you when the grass bag is full. The flap will blow open during use and then close when the collector is full of grass.

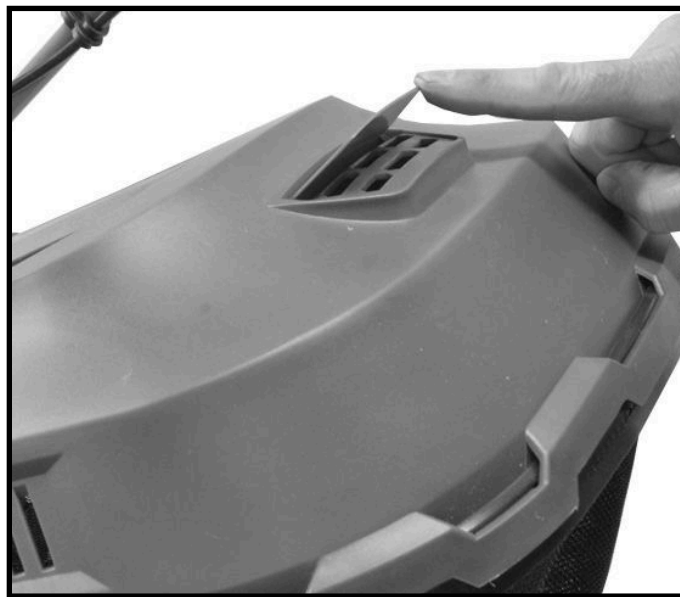

Operation

Mulching

This can be used to prevent the grass clippings from entering the collector box. The clippings will be mulched up, leaving the nutrients to be absorbed back into the lawn.

⚠ You must turn motor off before removing or installing the mulching plug.

- 1 To remove the plug, lift the rear flap on the mower and pull out the mulching plug.
- 2 To install the plug, lift the rear flap and clip into the two bottom catches. Close the rear flap.

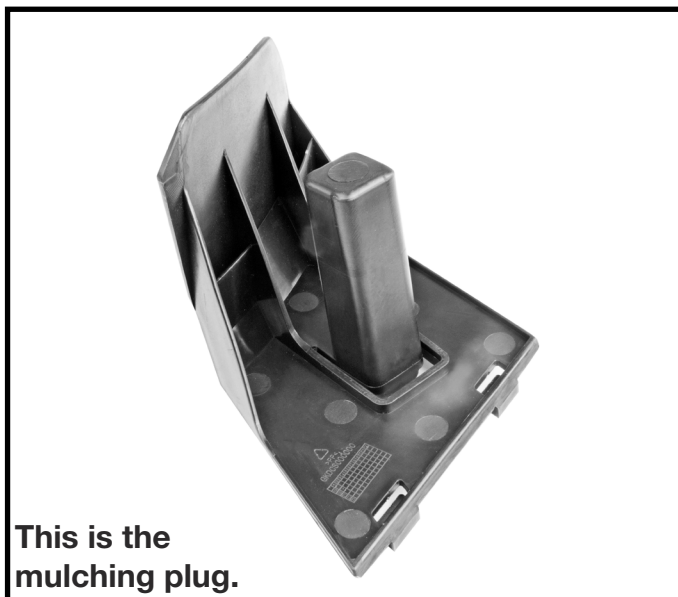
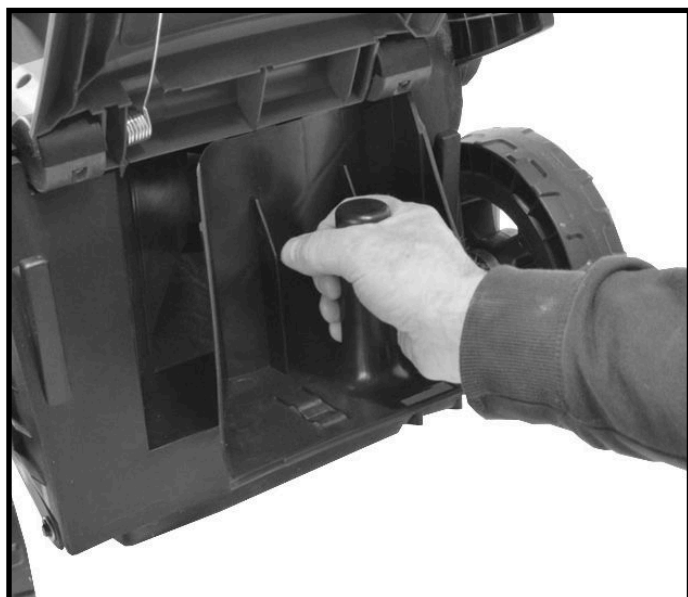
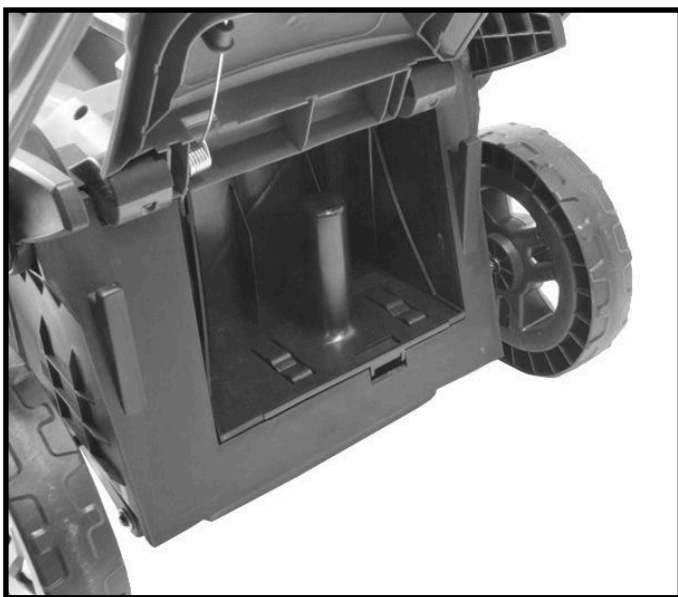

What Is Mulching?

Mulching is the intelligent way to keep your lawn healthy. This is when the grass clippings are cut into fine pieces which then fall back into the soil. These fine pieces are rich in nutrients and act as a natural fertiliser. This will keep your lawn healthy.

Operation

Cutting Height Adjustment

You can adjust the height to 5 positions.

- 1 Position 1 is the lowest and 5 is the highest. If your grass is quite long, set the height to a high position first and take an initial cut.

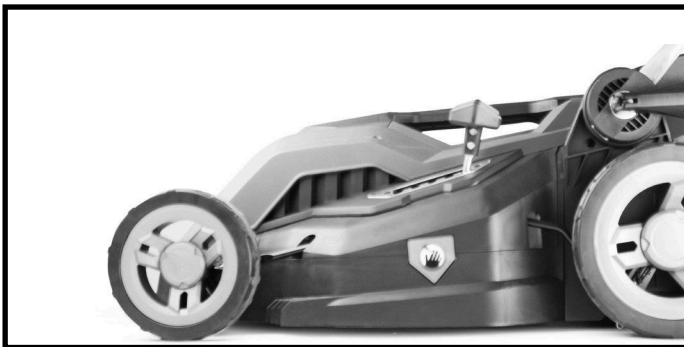
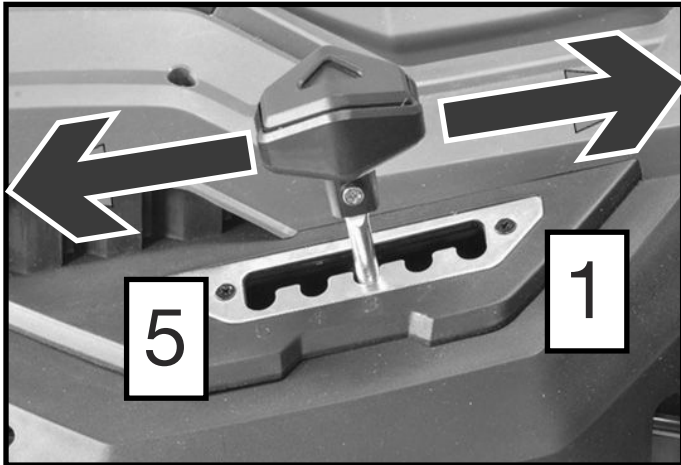

This is the lowest height setting.

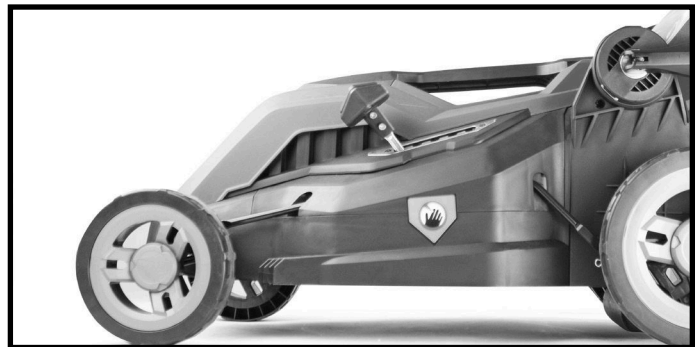

This is the highest height setting.

Rear Roller



The rear roller will enable the mower to provide attractive stripes to the lawn. It is spring loaded so it self adjusts to the required height.

Operation

Before Each Use

⚠ YOU MUST read and understand the full safety instruction manual before starting the machine.

- 1 Always ensure that the machine is in a safe working condition. Inspect and check safety devices and guards and check all nuts, bolts and screws are secure.
- 2 Make sure you know how to stop the machine and ensure you are familiar with emergency stop.
- 3 Start the machine following the instructions and stay clear of the machine's moving parts.

Method Of Cutting Grass

- 1 Make sure you keep the cable away from the cutting blade.
- 2 Coil up the cable close to the power source and work away from this area.
- 3 If the grass is long, use a high cutting height first. Then take a lower second cut.

General Mowing Tips

- 1 Maintain a constant cutting height of 3-5cm. Do not shorten the grass to less than half its original height.
- 2 Under certain conditions, such as very tall grass, it may be necessary to raise the height of cut to reduce pushing effort, prevent overloading of the motor and leaving clumps of grass clippings.
- 3 It may also be necessary to reduce ground speed and/or push the lawnmower over the area a second time. For extremely heavy cutting, reduce the width of cut by overlapping the previously cut path and mow slowly.

Recommended Mowing Schedule

Spring (March, April & May)

Mow once a week on a high to medium height setting.

Summer (June, July & August)

Mow twice a week under good growing conditions on a low setting. In dry conditions, mow once a week on a medium to high height setting.

Autumn (September, October & November)

Mow once a week on a medium height setting.

Winter (December, January & February)

Mow as required on a high height setting.

Starting / Stopping

Starting

- 1 Before starting the motor, make sure the mower is not sitting on long grass.
- 2 Make sure the cable is well away from the cutting blade.
- 3 Push and hold in the red button on the handle.
- 4 Now pull one of the Operator Presence Control (OPC) levers in.

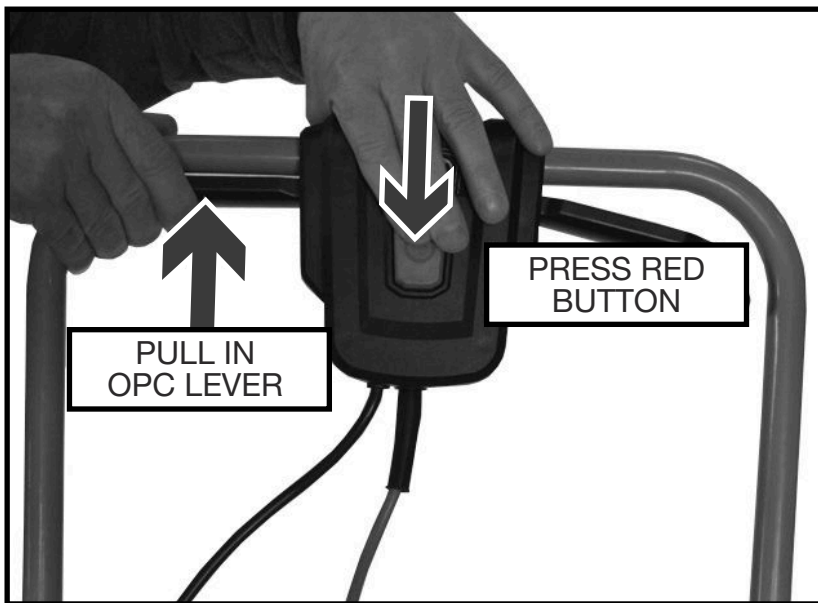

Stopping

- 1 To stop the motor, release the OPC lever.

Maintenance

⚠ Maintenance Safety

⚠ IMPORTANT - Routine and accurate maintenance is essential for maintaining original machine safety and performance levels.

⚠ WARNING - Before cleaning or doing maintenance work, you need to stop the machine and read the relevant instructions. You need to wear proper clothing and protective gloves whenever your hands are at risk.

⚠ If there are worn or damaged parts, never use the machine. Faulty or worn-out parts must be replaced and not repaired. You must only use original spare parts. The use of non-original and/or incorrectly fitted parts will jeopardize the safety of the machine. This may also cause accidents or personal injuries for which the manufacturer is under no circumstance liable or responsible.

⚠ Any maintenance operations or adjustments not explained in this manual must be carried out by your Dealer or a specialised Service Centre with the necessary knowledge and equipment to ensure that the work is done correctly maintaining the machine's original safety level. Any operations performed in unauthorised centres or by unqualified persons will invalidate the Warranty and all obligations and responsibilities of the Manufacturer.

⚠ Be very careful during adjustment of the machine to prevent entrapment of the fingers between moving parts and fixed parts of the machine.

Checking Your Machine

When checking your machine, we recommend you:

- Check for worn or damaged parts.
- Make sure all nuts, screws and bolts are tight.
- Make sure all warning stickers are in place and not damaged.
- Frequently check the lawnmower and ensure that all grass deposits are removed from beneath the deck.
- Check the blade for damage.

Maintenance

Cleaning

⚠ CAUTION - DO NOT use a hose pipe or pressure washer to clean the machine.

⚠ NOTE Machine must be switched off and disconnected from the power supply.

After Each Use

- You must remove grass and mud from the machine to prevent it from drying. This will cause problems the next time the machine is used.
 - Wipe the machine down with a cloth.
 - For larger build ups of debris, use a scraper or similar product.
 - Avoid using solvents when cleaning plastic parts. Most plastics are susceptible to damage from various types of commercial solvents and may be damaged by their use.
- 1 Make sure the power has been disconnected to the lawnmower
 - 2 Clean the cooling vents to the motor to prevent overheating. There are vents on the top of the mower and under the deck of the mower.
 - 3 Tip the mower on its side and wear gloves to protect yourself from the blade.
 - 4 Clean the old grass clippings away using a stiff brush.
 - 5 Clean the old grass from around the roller and wheels.
 - 6 Do not use a water jet or pressure washer to clean the machine. This will damage the electric motor.
 - 7 Use a damp cloth with mild detergent to clean the top casing.

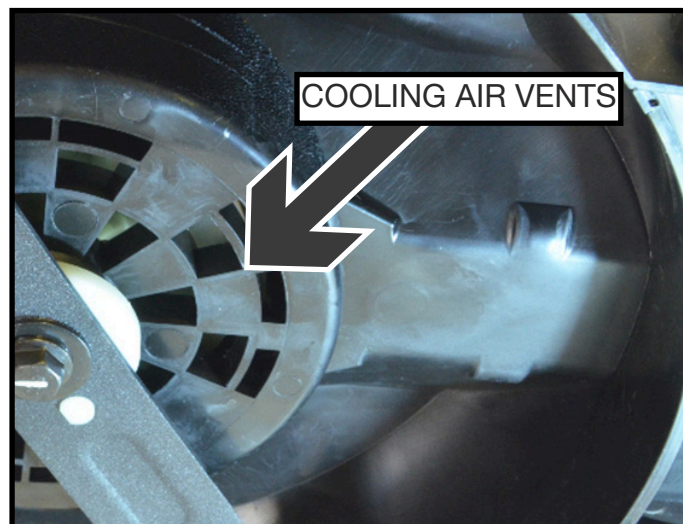
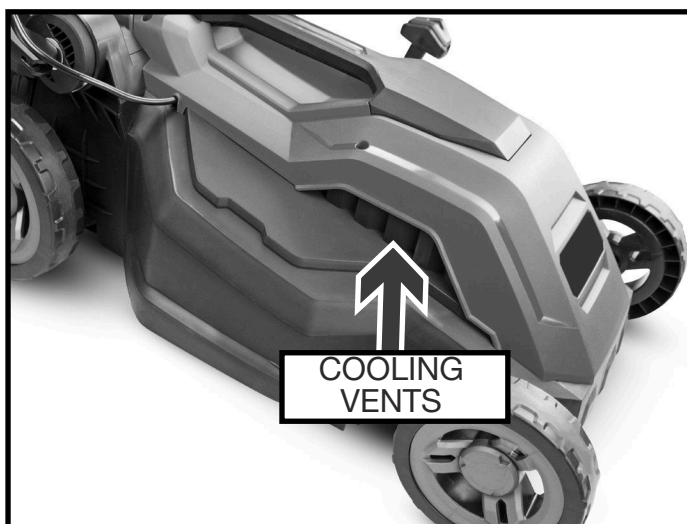

Transportation

Whenever the machine is to be handled, lifted, transported or tilted, you must:

- 1 Wear sturdy work gloves.
- 2 Hold the machine at the points that offer a safe grip, taking into account the weight and relative distribution of the same.
- 3 Use an appropriate number of people for the weight of the machine and the characteristics of the vehicle or the place where it must be placed or collected.
- 4 You must make sure that machine movements do not cause petrol leaks, damage or injuries.
- 5 During transport, make sure to fasten the machine securely with cables or straps.
- 6 The machine must be transported on a flat surface.

Maintenance

Storage

Where To Store

- ⚠ Store in a cool, dry place away from sources of ignition and varying changes in temperature.
- ⚠ Store on a flat and level surface with all wheels on the ground.
- ⚠ DO NOT stack other items on top of the machine when in storage.
- ⚠ Store the machine in a safe place, out of the reach of children or anyone who is not familiar with operation.
- ⚠ DO NOT store a machine that has not been given time to fully cool down.

How To Store

After use, please follow the below steps before storing your machine.

- 1 Allow the machine to fully cool down.
- 2 Clean the machine. See the 'Cleaning' section.
- 3 Undo the top handle nuts and carefully fold over the top handle. Make sure you do not trap the cable in the handle joints.
- 4 Cover in a soft dry cloth.



Maintenance

The Blade

WARNING

- Never touch a rotating blade.
- Check the blade in order to get a good cut. The blade should always be sharp and well balanced. At regular intervals, check the tightness of all nuts, bolts and screws.
- If the blade hits an obstacle, check for damage and if the machine vibrates badly, stop the lawnmower and take it to a service dealer.
- It is best if all interventions on the blade are done at a specialised centre that has the special tools and equipment.

- 1 First disconnect the power to the mower.
- 2 You **MUST** wear gloves to protect your hands from being cut when working with the blade. Inspect the blade for chips or a blunt cutting edge.
- 3 To sharpen the blade you will have to remove it.
- 4 Using a suitable ring spanner or socket wrench, undo the central bolt by turning anticlockwise. It will be very tight.
- 5 You can take the blade for sharpening to a local repair workshop or you can do it yourself using suitable metal grinding equipment. Please use Eye and Ear protection.
- 6 If you do it yourself, make sure the blade is balanced by placing a nail through the central hole and seeing if the blade sits evenly.
- 7 Check the plastic blade boss/adaptor for damage. If your blade has hit a foreign object, the two lugs which locate the blade may have sheared off. This can be purchased by contacting us.
- 8 Replace the blade and tighten the central bolt very tightly. Only original blades must be used on this machine.



Maintenance

Wheels

- 1 The wheels can be removed for greasing with a general purpose grease before each grass cutting season.
- 2 Pull the wheel trim off and remove the R Clip. Slide the wheel off and apply some grease to the axle.



Troubleshooting

⚠ For faults not listed in this table, or which you cannot resolve by yourself, please contact our aftersales team. Where necessary, all corrective actions should be carried out by suitably qualified persons.

| | |
|-----------------------------------|--|
| Motor won't start | <ul style="list-style-type: none">• Check the fuse in the plug.• Check the cable for damage.• Make sure you are holding in the RED button while pulling the OPC lever.• If the motor is hot, leave to cool down and try again.• Check underneath for excessive build-up of grass clippings which may be jamming the blade. |
| Mower not collecting grass | <ul style="list-style-type: none">• Make sure mulching plug is removed.• Clean under the deck of the mower and the exit chute into the grass collector. |
| Mower does not cut grass cleanly. | <ul style="list-style-type: none">• Check if the blade is blunt. Sharpen or replace if needed.• Check that the cutting height suits the grass length. |

Technical Data

Specifications

| | |
|--------------------------|---|
| Model | GT38E |
| Voltage | 230V - 50Hz |
| Motor Power Rating | 1600W |
| No Load Speed | 3700rpm |
| Cutting Height | 20-70mm (5 Positions) |
| Cutting Width | 380mm / 38cm |
| Grass Collector Capacity | 40L |
| Measured Sound Level | 81.3dB, K=3m/s ² |
| Guaranteed Sound Level | 96dB |
| Vibration Value | 2.7m/s ² , K=0.5m/s ² |
| Net Weight | 12.5kg |

Recycling And Disposal

Recycling And Disposal



We do not offer a takeback scheme for the recovery of Waste Electrical Electronic Equipment (WEEE) & Batteries. Instead the responsibility to dispose of WEEE and/or Batteries is passed onto you by us.

So when it becomes necessary to dispose of your machine you must take it to your local Civic Amenity Site. For further information please contact your local Authority for disposal advice.

You **MUST** make sure that all unused oil and fuel is disposed of correctly either beforehand or at your local Civic Amenity Site.

- Under NO circumstances must any fuel or oil be put down any drains.
- Certain products contain WEEE waste which should not be disposed of in your domestic waste.
- You **MUST** recycle WEEE in accordance with your local authority or recycling centre.
- Certain products contain batteries which should not be disposed of in your domestic waste.
- You **MUST** recycle batteries in accordance with your local authority or recycling centre.
- Unwanted packaging and materials should be stored and taken to a recycling centre so it can be disposed of in a manner which is compatible with the environment.

We are a Member of the VALPAK National Compliance Scheme and our registration number is **RM08660**. For further information about disposal please contact your Local Authority.

You can also get more advice and guidance about recycling at the following website <http://www.recycle-more.co.uk>

Should you pass this product on to another user either sold or loaned, you **MUST** pass on this user manual. This will make sure that all other users can use and maintain this machine safely.

Environmental Protection

1. Environmental protection should be a priority of considerable importance when using the machine, for the benefit of both social coexistence and the environment in which we live. Try not to cause any disturbance to the surrounding area.
2. You must comply with local regulations and provisions for the disposal of packaging, oils, petrol, filters, damaged parts or any elements which have a strong impact on the environment. This waste must not be disposed of as normal waste. It needs to be separated and taken to specified waste disposal centres where the material will be recycled.
3. You must comply with local regulations for the disposal of waste materials after mowing.
4. When disposing, do not pollute the environment with the machine, but hand it over to a disposal centre, in accordance with the local laws in force.

Declaration Of Conformity

Importer and Authorised Representative

Genpower Ltd
Isaac Way, Pembroke Dock, SA72 4RW

Country of Origin: China

Description: 1600W Lawnmower

SKU Code: GT38E

Date of Issue: 29/10/2021

Regulations and Directives of Compliance

- 2006/42/EC The Machine Directive
- 2014/30/EU EMC Directive
- 2000/14/EC Noise Emissions
- 2011/65/EU RoHS

Statement of Declaration

We the importer and authorised representative of the product described confirm conformity within the provisions of applicable regulations and directives listed within this document.

Signed on Behalf of Genpower Ltd

Place of Issue: Genpower Ltd

Signatory Name: Roland Llewelin

Position: Managing Director

R J Llewelin
.....



Useful Information

Warranty

Proof of purchase will be required before you make a warranty claim.

Manual Updates

Our manuals are constantly being reviewed and updated. Should you find an error, omission or something unclear, please contact us for assistance.

We reserve the right to make any modifications without prior notice whenever necessary.

Our latest manuals are also placed online.

Returning Your Product

If you are returning your product, please contact the dealer for their returns policy.

Leaving A Review

We work very hard to give all of our customers the best possible service. If you have any problems, before leaving negative feedback, please contact us to give us a chance to resolve the issue. We would be delighted if you left us positive feedback!

Ordering Spare Parts

You can find the spare part you are looking for in the 'Spare Parts' section of this manual or visit power-spares.co.uk

Product Information

Information

As soon as you have purchased the machine, we recommend that you fill out the following. If you need to contact an authorised dealer or customer service for information on servicing, you may need to provide the following information.

The model number and serial number can be found on the grey specification sticker on your machine.

Date Of Purchase:

Dealer Name:.....

Dealer Phone:.....

Model Number:.....

Serial Number:.....

Need Help? Talk To Our Experts

Contact Us

Our friendly aftersales team will be more than happy to help you.



Phone

Call our team on 01646 687880, open Monday-Friday 8.30am-5pm.



Email

aftersales@genpower.co.uk



Post

Genpower Limited, Isaac Way, Pembroke Dock, Pembrokeshire, SA72 4RW, UK.

Importer:
GENPOWER LTD
Isaac Way, London Road,
Pembroke Dock, UNITED KINGDOM, SA72 4RW
T: +44 (0) 1646 687 880 F: +44 (0) 1646 686 198

Imported/Distributed by Genpower Ltd for The United Kingdom & Ireland