

COBRA

MODEL: S40C (TS40-S)

COBRA SCARIFIER OWNER'S MANUAL



Cobra Garden Machinery

Henton and Chattell Ltd., London Road, Nottingham NG2 3HW UK

www.cobragarden.co.uk

CONTENTS

SECTION 1	SYMBOLS MARKED ON THE PRODUCT.....	3
SECTION 2	GENERAL SAFETY RULES.....	3
SECTION 3	PARTS DESCRIPTION.....	6
SECTION 4	TECHNICAL DATA.....	6
SECTION 5	ASSEMBLY.....	7
SECTION 6	OPERATION INSTRUCTIONS.....	9
SECTION 7	CHANGING THE SPRING TINE OR AERATOR CARTRIDGE	11
SECTION 8	FUNCTIONAL DESCRIPTION.....	13
SECTION 9	MAINTENANCE	13
SECTION 10	LUBRICATION.....	13
SECTION 11	CLEANING.....	13
SECTION 12	STORAGE & TRANSPORTING.....	15
SECTION 13	TROUBLESHOOTING	16
SECTION 14	WARRANTY.....	17
SECTION 15	ENVIRONMENT.....	17
SECTION 16	EC-DECLARATION OF CONFORMITY.....	18

! WARNING:

For your own safety please read this manual before attempting to operate your new scarifier. Failure to follow instructions can result in serious personal injury. Spend a few moments to familiarise yourself with your machinery before each use.

1. SYMBOLS MARKED ON THE PRODUCT



Fig. A

B.1 Read Operator's Manual.

B.2 Keep bystanders away.

B.3 Pay attention to the operator's hands and feet to avoid injury. KEEP HANDS AND FEET AWAY.

B.4 Fuel is flammable, keep fire away. Do not add fuel with running machine.

B.5 Toxic fumes; don't operate indoors, including your garage or shed.

B.6 When mowing, please wear protective glasses and ear plugs to defend the operator himself.

B.7 When repairing, please remove the spark plug, before undertaking repair work according to the operational manual.

B.8 Caution: Engine hot.

2. GENERAL SAFETY RULES

! WARNING: When using petrol tools, basic safety precautions, including the following, should always be followed to reduce the risk of serious personal injury and/or damage to the unit. Read all these instruction before operating this product and retain these instructions for future reference.

! WARNING: This machine produces an electromagnetic field during operation. This field may under some circumstances interfere with active or passive medical implants. To reduce the risk of serious or fatal injury, we recommend persons with medical implants to consult their physician and the medical implant manufacturer before operating this machine.

Training

1. Before using the scarifier read the instructions carefully. Familiarise yourself with the controls and pay particular attention in learning how to stop the machine in an emergency.
2. Never allow children or people unfamiliar with these instructions to use the lawn scarifier. Local regulations can restrict the age of the operator.
3. Never use while people, especially children or pets are nearby.
4. Never use the scarifier if the operator is taking medicine or substances that could affect or impair his

ability to react or concentrate.

5. Keep in mind that the operator or user is responsible for accidents or hazards occurring to other people or their property.

Before you start

1. While scarifying, always wear substantial footwear and long trousers. Do not operate the equipment when barefoot or wearing open toed sandals.
2. Thoroughly inspect the area where the equipment is to be used and remove all objects which can damage or be thrown by the machine.
3. **WARNING** - Petrol is highly flammable.
 - Store fuel in containers specifically designed for this purpose.
 - Refuel outdoors only and do not smoke while refuelling; add fuel before starting the engine.
 - Never remove the cap of the fuel tank or add petrol while the engine is running or when the engine is hot.
 - If petrol is spilled, do not attempt to start the engine, but move the machine away from the area of spillage and avoid creating any source of ignition until petrol vapours have dissipated.
 - Replace all fuel tank and container caps securely.
4. Replace faulty silencers.
5. Before using, always visually inspect to see that the blade, blade bolts and cutter assembly are not worn or damaged. Replace worn or damaged blades and bolts in sets to preserve balance.

Operation and Caution

1. Do not operate the engine in a confined space where dangerous carbon monoxide fumes can collect, refuel outdoors only.
2. Use only in daylight or in good artificial light.
3. Avoid operating the equipment in wet grass, where feasible.
4. Always be sure of your footing on slopes.
5. Walk, never run, always be in control of the scarifier and never allow yourself to be pulled along.
6. Operate across the face of slopes, never up and down.
7. Exercise extreme caution when changing direction on slopes.
8. Do not use on excessively steep slopes of more than 20°
9. Use extreme caution when reversing or pulling the lawn scarifier towards you.
10. Stop the blade if the lawn scarifier has to be tilted for transportation when crossing surfaces other than grass, and when transporting the lawn scarifier to and from the area to be mowed
11. Never operate the lawn scarifier with defective guards, or without safety devices, for example deflectors and/or grass catchers, in place.
12. Do not change the engine governor settings or over speed the engine.
13. Before starting the engine disengage all blades and drive clutches.
14. Keep your feet well away from the blade when starting the engine and in accordance with the instructions.
15. Do not tilt the lawn scarifier when starting the engine and always start on a flat surface free from long grass.

16. Do not start the engine when standing in front of the discharge chute.
17. Never put hands or feet near or under rotating parts. Keep clear of the discharge opening at all times.
18. Always ensure the engine is fully switched off before picking up/carrying the scarifier.
19. Stop the engine and disconnect the spark plug wire, make sure that all moving parts have come to a complete stop and, where a key is fitted remove the key, make sure engine has had time to cool.
 - Before unclogging chute and clearing blockages.

- Before checking, cleaning or working on the machinery.
 - After striking a foreign object. Inspect the scarifier for damage and make repairs before restarting.
 - If the machinery starts to vibrate abnormally (check immediately).
20. Stop the engine and disconnect the spark plug wire, make sure that all moving parts have come to a complete stop and, where a key is fitted remove the key, make sure engine is completely cooled.
- Whenever you leave the lawn scarifier.
 - Before refuelling.
21. Reduce the throttle setting during engine shut down and, if the engine is provided with a shut-off valve, turn the fuel valve off at the conclusion of work.

Maintenance and Storage

1. Keep all nuts, bolts and screws tight to be sure the equipment is in safe working condition.
2. Never store the equipment with petrol in the tank inside a building where fuel vapours can reach an open flame or spark or where the temperature is high.
3. Before storage allow the engine to cool.
4. To reduce the fire hazard, keep the engine, silencer, battery compartment and petrol storage area free of grass, leaves, or excessive grease.
5. Check the grass catcher and deflector frequently for wear or deterioration.
6. Replace worn or damaged parts for safety. Genuine parts should always be used as parts of inferior quality can damage the equipment and compromise safety.
7. If the fuel tank has to be drained, this should be done outdoors. Always ensure engine is completely cooled before starting this task.
8. If the blade needs to be removed, wear strong gloves to prevent injury to hands and fingers. Check the blades balance after sharpening.
9. When transporting the machine make sure you close the fuel cut off. Be careful to ensure weight is evenly distributed. Wear strong gloves.
10. When tilting the machine never tilt towards the air filter as this may become damaged with fuel.
11. Never crank the engine when the spark plug is removed.
12. Frequently check the fuel lines and fittings for damage and cracks, replace if necessary
13. Never start the engine with the air filter cover removed.
14. Carefully clean the scarifier and grass bag after use to remove debris as this can damage and corrode.

Fertilisers and top dressings are particularly corrosive.

15. In time your chassis may peel because of the abrasive action of the debris making contact. This can be remedied by touching up paintwork where necessary to prevent corrosion.



Warning: Do not touch rotating blades.



Warning: Refuel in a well ventilated area with the engine stopped.

3. PARTS DESCRIPTION



Fig.1

- | | | |
|--------------------------|------------------------------------|---------------------------|
| 1. Upper handle | 2. Transport position lever | 3. Recoil starter handle |
| 4. Catcher | 5. Wheel | 6. Height adjustment knob |
| 7. Handle wheel knob | 8. Operator presence control (OPC) | 9. Engine switch |
| 10. Choke and fuel valve | 11. Oil filler | |

4. TECHNICAL DATA

Model	S40C (TS40-S)
Engine Type	HWASDAN H210
Engine Displacement	212cm ³
Nominal Power	4.0kW
Rated Speed	3400rpm/min
Fuel Tank Capacity	3.6L
Oil Tank Capacity	0.6L
Grass catcher capacity	45L
Working Width	400mm
Net Weight	39kg
Height Adjustment	-15-5mm

Model	S40C (TS40-S)
Sound pressure level at the operator's position	85.9dB(A) K=3 dB(A)
Measured sound power level	101.2dB(A) K=3.43dB(A)
Guaranteed sound power level	105dB(A)
Vibration	7.03m/s ² K=1.5 m/s ²

5. ASSEMBLY

5.1 FOLDING HANDLE

1. Fix the lower handlebar into the unit body with bolts, washers and locking knobs. (Fig. 2A/Fig.2B/Fig.2C)
2. Connect the lower handlebar and upper handlebar with bolts, washers and locking knobs. (Fig.2D/Fig.2E/Fig.2F)
3. Attach the cable-clamps to the position shown and then attach the cable. (Fig.2G)



Fig.2A

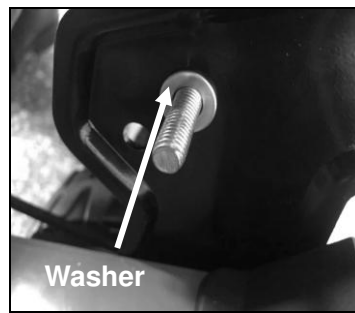

Fig.2B



Fig.2C

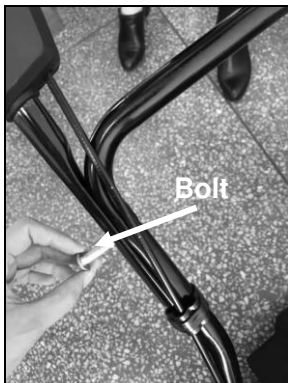

Fig.2D



Fig.2E

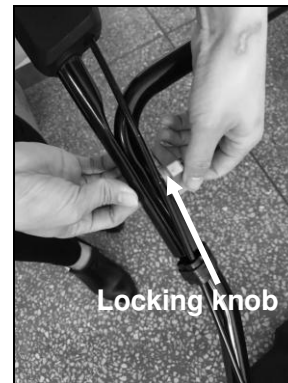

Fig.2F



Fig.2G

5.2 ADJUSTMENT FOR AN APPROPRIATE ANGLE

1. Screw out the locking knobs which fixed the lower handle. (Fig.3A)
2. Move the lower handle up or down, adjust it to the proper height. There are 2 adjusting heights to be choose on the lawn scarifier; at 2 height, lower handle to the ground is highest, 1 height is the lowest.
3. Adjusting to the proper height, then fix the lower handle using the locking knobs.

!WARNING: The left side and right side of lower handle must adjust to the same height.

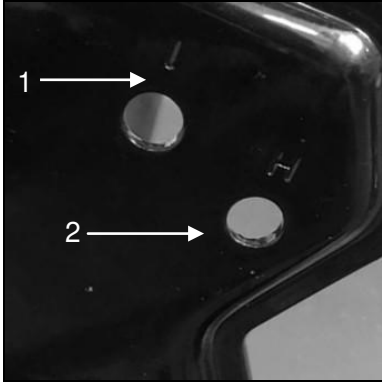

Fig.3A

1.3 MOUNTING AND DISMOUNTING THE GRASS CATCHER

To fit: Raise the rear cover and hitch the grass catcher on rear of scarifier. (Fig.4A/Fig.4B/Fig.4C).

To remove: Grasp and lift the rear cover, remove grass catcher.

!WARNING: Before you ever hook the grass catcher to the scarifier, you must ensure that the engine is stopped and the cutting unit is not rotating.



Fig. 4A



Fig. 4B



Fig. 4C

5.4 STARTER HANDLE

Move the starter handle from the engine to the rope guide. (Fig.5)



Fig.5

5.5 DEPTH OF CUT

Apply outward pressure to disengage lever from rack. Move lever forward or back to adjust height. (Fig. 6 and see clause 6.4).



Fig. 6

6. OPERATING INSTRUCTIONS

Service the engine with petrol and oil as instructed in the separate engine manual packed in your scarifier. Read instructions carefully.

⚠ WARNING! Petrol is highly flammable.

Store fuel in containers specifically designed for this purpose.

Refuel outdoors only, before starting the engine and do not smoke while refueling or handling fuel.

Never remove the cap of the fuel tank or add petrol while the engine is running or when the engine is hot.

If petrol is spilled, do not attempt to start the engine but move the machine away from the area of spillage and avoid creating any source of ignition until petrol vapors have dissipated.

Replace all fuel tanks and container caps securely.

Before tipping the scarifier to maintain the blade or drain oil, remove fuel from tank.

⚠ WARNING: Never fill fuel tank indoors, with engine running or until the engine has been allowed to cool for at least 15 minutes after running.

6.1 TO START ENGINE

1. Before starting engine, please turn the engine switch to the “ON” position. (Fig.7A)
3. To start a cold engine, move the Carburetor lever to the “on” position (Fig. 7B). Keep the choke lever stay to the “off” position (Fig. 7B).
4. Standing behind the unit, grasp the brake control handle (OPC) and hold it against the Lower handle. (Fig. 7C)
5. Keep hold of the brake lever (OPC) as shown Fig.7C and grasp the starter handle as shown Fig 7D pull up rapidly. Return it slowly to the rope guide bolt after engine starts.
6. Move the choke lever to the “on” position. (Fig.7F)

⚠ Note! When the cutter deck is in contact with the ground, the unit can move.

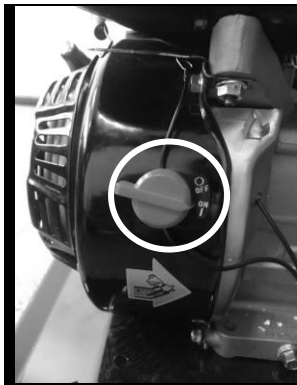

Fig.7A



Fig.7B



Fig.7C



Fig.7D

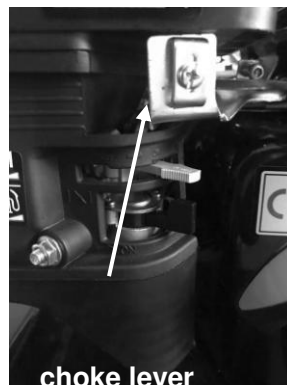

Fig.7E

6.2 TO STOP ENGINE

⚠ CAUTION: The blade continues to rotate for a few seconds after the engine is shut off.

1. Release the brake control handle (OPC) to stop the engine and blade. (Fig. 8A)
2. Move the engine switch to "OFF" position. (Fig.8B)



Fig. 8A

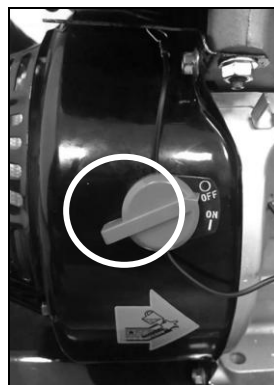

Fig. 8B

6.3 GRASS CATCHER

6.3.1 Work without the grass catcher (optional)

For scarifier, you can work with grass catcher or without grass catcher. Whenever you detach the grass catcher, the deflector flap dropped down. When scarifying without the grass catcher attached, the cuttings are ejected straight onto the ground. (Fig.9A)

6.3.2 Work with the grass catcher

When working with grass catcher, the cuttings are ejected to the grass catcher. If the grass catcher is full of

cuttings, you will need to empty and clean the grass catcher.

1. Stop the engine and wait until it comes to a stop.
2. Lift the deflector flap and unhook the grass catcher. (Fig.9B)
3. Empty out the contents.



Fig.9A



Fig.9B

6.4 HEIGHT ADJUSTMENT INSTRUCTIONS

⚠ CAUTION: Do not at any time make any adjustment to scarifier without first stopping the engine.

Your scarifier is equipped with a depth adjustment lever offering a range of working positions. The working positions are -3mm, -6mm, -9mm, -12mm, -15mm height.

1. Stop the scarifier and disconnect spark plug cable before changing scarifier cutting height.
2. To change the height of cut by turning the front knob clockwise rotation or counter clockwise to the required height.
3. Move the transport lever to transport position to prevent cutter deck from touching the ground after finishing the work.



Fig.10A

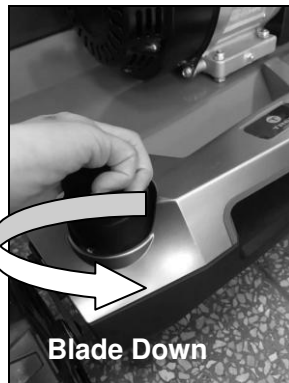

Fig.10B

7. REPLACEMENT OF THE SPRING TINE & AERATOR

⚠ WARNING: Be sure to wear work gloves. Switch off the engine.

⚠ Caution: use only original scarifier/aerator shafts approved by the manufacturer. The equipment can be assembled with the scarifying roller or the aerator roller.

Only replace the roller with an original **Cobra** roller, as this will ensure top performance and safety under all conditions.

To change the scarifying roller or the aerator roller, which is available as an option, proceed as follows.

1. Switch off the engine and leave to cool down.
2. Remove spark-plug terminal.
3. Remove the grass catcher.
4. Raise the unit slightly at the front.



Note: Do not raise too high, fuel may run out of the tank, if required, drain fuel before changing the roller.

Remove the roller

1. Remove the four screws. (Fig.11B)
2. Lift the roller and pull out in the direction of the arrow. (Fig.11C)

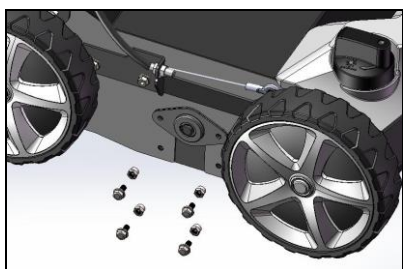

Fig.11A

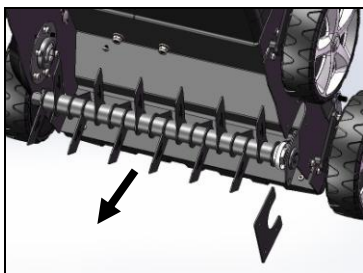

Fig.11B

Fitting the roller

1. Slide the new roller in the direction of the arrow, insert the shaft into the hexagonal socket and press the other side into the holder (Fig.11C/ Fig.11D/ Fig.11E).
2. Refit the roller with the two screws.
3. Check that the roller is seated correctly.
4. Assemble aerator shaft the same as the scarifier shaft. (Fig.11F/ Fig.11G/ Fig.11H).

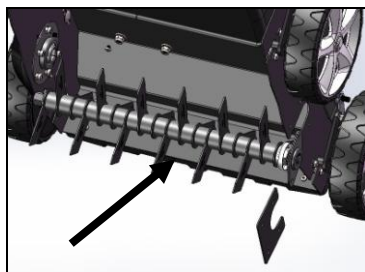

Fig.11C

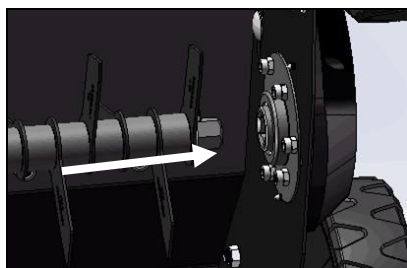

Fig.11D

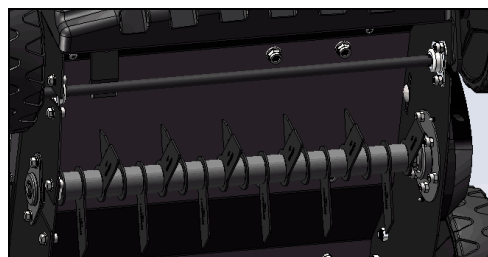

Fig.11E

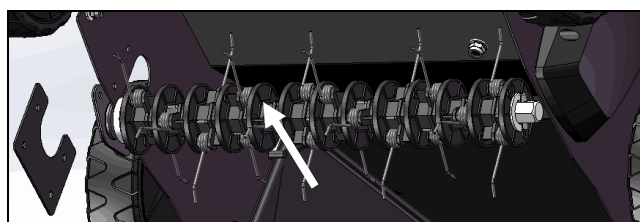

Fig.11F

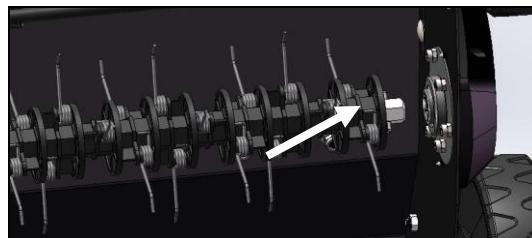

Fig.11G

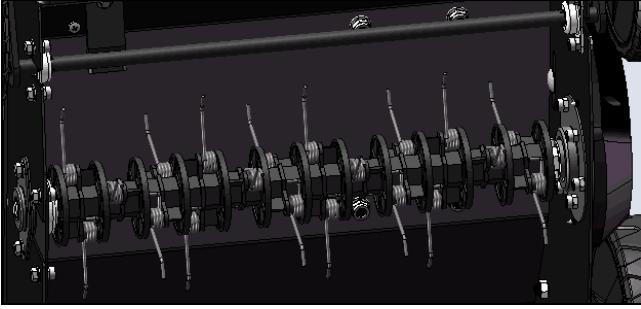

Fig.11H

8. FUNCTIONAL DESCRIPTION

The lawn scarifier is pushed by hand over the area of grass to be cut. The cutters are driven by a petrol engine. The depth of cut is set by varying the central height-adjustment mechanism.

Scarification:

The cutter deck rotates and removes the moss, lichen and weeds and conveys the scarified material to the outside or into the grass catcher. During cutting the cutters penetrate the ground and therefore ensure that the lawn is loosened and absorbs nutrients better. We recommend scarifying the lawn in spring (April/May) and autumn (October).

Aerating:

The cutter deck (aerator shaft) rotates and combs the lawn or aerates the mossy lawn. The removed moss is conveyed outwards or into the grass catcher. During aeration the surface of the ground is scratched; this improves water drainage and facilitates the absorption of oxygen.

We recommend aerating the lawn during the entire growing period as when required.

9. MAINTENANCE INSTRUCTIONS

SPARK PLUG

Use only original replacement spark plug. For best results, replace the spark plug every 100 hours of use.

BRAKE PADS

Check and/or replace the engine brake pads in service agent regularly, only original parts can be used as replacement.

ANNUAL SERVICE

The scarifier should be serviced regularly, in most circumstances this should be on an annual basis, but subject to working time this may be more often. Refer to the engine manual regarding engine service intervals.

10. LUBRICATION INSTRUCTIONS

⚠ CAUTION: DISCONNECT SPARK PLUG BEFORE SERVICING.

1. WHEELS-Lubricate the ball bearings in each wheel at least once a season with a light oil.
2. ENGINE-Follow engine manual for lubrication instructions.

11. CLEANING

⚠ CAUTION: Do not hose engine. Water can damage engine or contaminate the fuel system.

1. Wipe deck with dry cloth.
2. Hose under deck by tilting the scarifier so that the spark plug is up.

11.1 ENGINE AIR CLEANER

⚠ CAUTION: Do not allow dirt or dust to clog the air filter foam element.

The engine air cleaner element must be serviced (cleaned) after 25 hours normal mowing. The foam element must be serviced regularly if the scarifier is used in dry dusty conditions.

To CLEAN AIR FILTER

1. Remove cover. (Fig.12A)
2. Blow the the Filter element dust off . (Fig.12B).
3. Place a few drops of SAE30 oil on the foam filter and squeeze tightly to remove any excess oil.
4. Reinstall filter.
5. Close the filter cover.

⚠ NOTE: Replace filter if frayed, torn, damaged or unable to be cleaned.

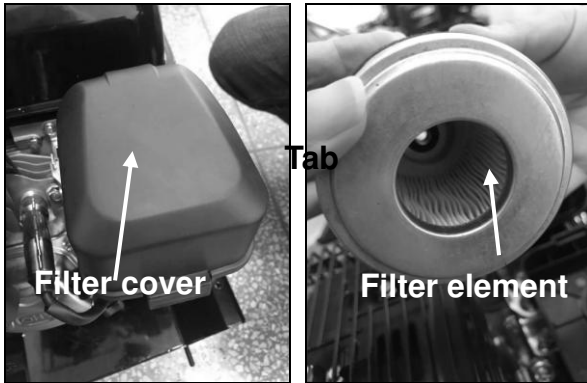

Fig.12A

Fig.12B

11.2 ENGINE

Refer to the separate engine manual for engine maintenance instructions.

Maintain engine oil as instructed in the separate engine manual packed with your unit.

Read and follow instructions carefully.

Service the air cleaner as per the engine manual under normal conditions. Clean every few hours under extremely dusty conditions. Poor engine performance and flooding usually indicates that the air cleaner should be serviced.

To service the air cleaner, refer to the separate engine manual packed with your unit.

The spark plug should be cleaned and the gap reset once a season. Spark plug replacement is recommended at the start of each mowing season; check the engine manual for correct plug type and gap specifications. Clean the engine regularly with a cloth or brush. Keep the cooling system (blower housing area) clean to permit proper air circulation which is essential to engine performance and life. Be certain to remove all grass, dirt and combustible debris from exhaust area.

12. STORAGE AND TRANSPORT

Storage

The following steps should be taken to prepare the lawn scarifier for storage.

1. Empty the tank.
 - a) Empty the petrol tank with a suction pump.

 **CAUTION!** Do not drain the petrol in a closed room, in close proximity of open fire, etc. Do not smoke!

Petrol fumes can cause explosion or fire.

- b) Start the engine and let it run until it has used up all remaining petrol and the engine stalls.
 - c) Remove the spark plug. Use an oilcan to fill approx. 20 ml oil into the combustion chamber. Operate the starter to evenly distribute the oil in the combustion chamber. Replace the spark plug.
2. Clean and grease the scarifier carefully as described above under "Lubrication instructions".
 3. Slightly grease the cutter to avoid corrosion. Always wear protective gloves.
 4. Store the lawn scarifier in a dry, clean and frost-protected place, out of reach of unauthorised persons.

 **CAUTION!** The engine must have completely cooled down before storing the scarifier.

 **NOTE:** - When storing any type of power equipment in an unventilated or material storage shed,

-Care should be taken to rust-proof the equipment. Using a light oil or silicone, coat the equipment, especially cables and all moving parts.

- Be careful not to bend or kink cables.

- If the starter rope becomes disconnected from rope guide on handle, disconnect and ground the spark plug wire, Depress the blade control handle and pull the starter rope out from engine slowly. Slip the starter rope into the rope guide bolt on handle.

Transport

1. Move transport lever to transport position.
2. Stopping the engine.
3. Do not transport with petrol in the scarifier within a vehicle.

 **Danger!**

Before transportation, always stop the engine and leave to cool down. Remove spark-plug terminal. The appliance must not be tilted when it is transported. When transporting the scarifier in or on a vehicle, ensure that it does not move around unintentionally.

Empty the fuel tank before transporting the unit. Filler cap must be closed tightly.

13. TROUBLESHOOTING

Problem	Possible causes	Remedial action
Engine does not start	Throttle choke is not in the correct position	Move the throttle choke to correct position.
	Fuel tank is empty.	Fill tank with fuel: refer to ENGINE OWNERS MANUAL.
	Air cleaner element is dirty.	Clean air cleaner element: refer to ENGINE OWNERS MANUAL.
	Spark plug loose.	Tighten spark plug.
	Spark plug wire loose or disconnected from plug.	Install spark plug wire on spark plug.
	Spark plug gap is incorrect.	Set correct gap between electrodes.
	Spark plug is defective.	Install new, correctly gapped plug: refer to ENGINE OWNERS MANUAL.
	Carburetor is flooded with fuel.	Remove air cleaner element and pull starter rope continuously until carburetor clears itself and install air cleaner element.
	Faulty ignition module.	Contact the service agent.
Motor speed drops off	Depth of cut too great	Set to smaller depth of cut
	Grass too high	Mow the lawn before scarifying
	Ejector channel blocked	Pull out spark plug connector, remove blockage.
	Air filter clogged	Clean air filter: refer to ENGINE OWNERS MANUAL.
Poor scarification results.	Depth of cut too small	Set to great depth of cut.
	Worn cutting blades	Having cutting blades replaced in a specialist workshop
Grass catcher never fills	Grass catcher is full/clogged	Stop the scarifier. Unload grass catcher or clean it
	Ejector channel blocked	Pull out spark plug connector, clean ejection channel
Unusual noises	Bolts, nuts or other mounting parts slack.	Tighten parts.
Vibration	Cutting assembly is loose.	Tighten blade cartridge.
	Cutting assembly is unbalanced.	Balance blade unit.

14. WARRANTY

This product is warranted in accordance with legal regulations for a 24 month period effective from the date of purchase by the first user.

This product will not be covered if used in a commercial application.

This warranty covers all material or production failures, it does not include: defects from normal wear and tear, parts such as, bearings, brushes, cables, air cleaning elements, brake pad, clutch disc, tyre, wheel, recoil starter rope, belts, cutter blades, plugs, lubricant oils and grease or accessories. Damage or defects resulting from abuse, accidents or alterations, natural fading of painted or plated surfaces, sheet peeling and other natural deterioration.

Any damage that occurs from the use of non-genuine Cobra parts will not be covered.

We reserve the right to reject any claim where the purchase cannot be verified or when it is clear that the product was not maintained properly. (Clean ventilation slots, carbon brushes and serviced regularly)

Expenses incidental to the warranty claim that are not covered;

-Compensation for loss of time, commercial loss or rental costs of substitute product.

-Costs incurred for transportation to and from the dealership.

Any damage that occurs from the following will not be covered; exposure of the product to smoke and soot, chemical agents, bird droppings or other animal waste, seawater, sea breeze, salt or other environmental phenomena.

Any damage resulting from operating methods other than those indicated in the owner's manual will not be covered.

Your purchase receipt must be kept as proof for date of purchase. Your un-dismantled mower must be returned to your dealer in an acceptably clean state, accompanied by your proof of purchase.

15. ENVIRONMENT

Should your machine need replacement after extended use, do not put it in the domestic waste but dispose of it in an environmentally safe way.

16. EC-DECLARATION OF CONFORMITY

EC Declaration of Conformity	
We herewith declare,	Cobra Garden Machinery Henton & Chattell Ltd, London Road, Nottingham NG2 3HW United Kingdom
That the following machine complies with the appropriate basic safety and health requirements of the EC Directive based on its design and type, as brought into circulation by us.	
In case of alteration of the machine, not agreed upon by us, this declaration will lose its validity	
Machine Description:	Petrol Lawn Scarifier
Machine Type:	S40C (TS40-S)
Displacement	212cm ³
Max. Operating Width:	400mm
Measured sound power level:	101.2dB(A)
Guaranteed sound power level:	105dB(A) Notified Body for EC Directive 2000/14/EC:0036 TÜV SÜD Industrie Service GmbH Ridlerstraße 57 + 65 80339 München Deutschland
Applicable EC Directives:	2006/42/EC 2014/30/EU 2000/14/EC 97/68/EC
Applicable Harmonized Standards:	EN ISO 5395-1 EN ISO 5395-2 EN ISO 14982
Authorized Signature/Date/ Place:	 Peter J. Chaloner 02/5/2019
Title of Signatory:	Managing Director
Name and address of the person authorised to compile the technical file	Cobra Garden Machinery Henton & Chattell Ltd, London Road, Nottingham NG2 3HW United Kingdom